

CHAPTER 11

SMALL ARMS

A good Navy is not a provocation to war. It is the surest guarantee of peace.

—Theodore Roosevelt

A number of duty assignments in the Navy may require you to be armed with a rifle or pistol. Examples of shipboard duty assignments include the forecastle, fantail, and pier sentry watches, quarterdeck, and magazine security watches. Examples of ashore duty assignments include base security forces and duties of Seabee personnel. Although none of these assignments may be your normal watch-standing duties, you may be required to support these or other security forces at any time. For this reason, you must be familiar with the proper use and care of small arms.

Strictly defined, the term *small arm* means any firearm of .60-caliber, 15-mm, or smaller bore. However, the term is generally considered to mean a weapon intended to be fired from the hand or shoulder, such as a rifle or a pistol.

At most naval commands, the small arms carried by security watches are maintained by armory personnel. Armory personnel should give you instructions on the proper use and handling of small arms.

SMALL ARMS SAFETY PRECAUTIONS

Learning Objective: When you finish this chapter, you will be able to—

- Recognize the purpose for and identify the safety precautions to follow when using small arms.

Before you learn to use any firearm, you must learn to handle it safely. **Remember, firearms are dangerous.** Their purpose is to kill or to cause injury.

NOTE

When at the firing range, follow all safety precautions.

Every firearm used by Navy personnel has some type of built-in safety device, and some have more than one. The safety device guards against accidental

discharge of a firearm. In almost every case of accidental shooting, negligence or carelessness is the prime cause. A weapon is only as safe as the person using it. Learn to respect each firearm as a deadly weapon.

You should observe the following general precautions when handling any type of firearm:

1. Treat every weapon with respect. Consider it loaded.
2. Never point a weapon at anything or anyone you do not intend to shoot.
3. Always make sure that the bore is clear and that all oil and grease have been removed from the barrel and chamber before firing.
4. Use only the proper size of ammunition.
5. Unload firearms before transporting them to and from a shooting area.
6. Always carry the firearm so as to control the direction of the muzzle. Keep the muzzle pointed in a safe direction until ready to fire.
7. Keep the safety on until you are ready to shoot.
8. Never shoot until you have positively identified the target.
9. Unload unattended weapons. At home, store firearms (with trigger locks installed) and ammunition out of the reach of children.
10. Do not climb trees or fences with a loaded firearm.
11. Do not pull a firearm toward you by the muzzle.
12. Avoid shooting a rifle over a hard, flat surface or body of water because of possible erratic and lengthy bullet ricochets.
13. Like oil and water, firearms and alcohol do not mix. Do not drink alcoholic beverages or partake of any narcotic or drug before or during shooting activities.

14. Know your weapon—its shooting characteristics, its safeties, and its loading and unloading procedures.
15. Never indulge in horseplay when carrying a firearm.

In addition to observing these safety precautions when handling and using firearms, you should take steps to protect your hearing and sight, particularly when you are exposed to repeated small arms fire such as that on a rifle or pistol range. Blast noise from small arms fire may cause a temporary or permanent hearing loss. The extent of injury depends on a number of factors, such as intensity of the noise, length of exposure, and your own sensitivity to noise hazards.

Two general types of personal ear protective devices are used to reduce noise and thus protect the ear. These are the insert type (earplug) and the circumaural type (covers the entire outer ear). The circumaural type is sometimes referred to as *Mickey Mouse ears*.

If you work in a noise hazard area, you may be fitted with a pair of earplugs. It's important to have the plugs fitted by a qualified member of the medical department because each person's auditory canals are a different size and structure.

The Mickey Mouse ears (fig. 11-1) are made with rigid plastic ear cups lined with foam, plastic, or rubber to provide a comfortable seal around the outer ear. The cups are connected over the head with an adjustable spring type of headband for a snug fit.

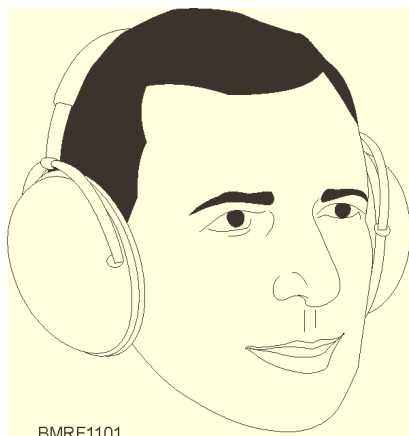

BMRF1101

Figure 11-1.—Circumaural (Mickey Mouse) type of ear protector.

Protecting your sight is as important as protecting your hearing. The Navy has several types of safety glasses and goggles that provide adequate protection from the danger of small arms. They range from the standard safety goggles used in everyday work to prescription safety glasses.

When you are on the range, use these protective devices so that you will always be able to see and hear the full spectrum of sounds and sights you see and hear today.

REVIEW 1 QUESTIONS

- Q1. When handling a firearm, you should NOT take which of the following actions?
 - a. Always treat a weapon as if it were loaded
 - b. Never point a weapon at anything or anyone you don't intend to shoot
 - c. Carry the weapon by the muzzle as long as the safety is on
 - d. Never engage in horseplay when carrying a firearm
- Q2. List the protective equipment you should wear when firing a weapon.
 - a.
 - b.

THE M14 RIFLE

Learning Objective: When you finish this chapter, you will be able to—

- Identify the M14 rifle.

The 7.62-mm M14 (fig. 11-2) rifle is a lightweight, air-cooled, gas-operated, magazine-fed shoulder weapon. It was widely used during Vietnam. Since then, it has since been replaced by the M16. It is designed for semiautomatic or automatic fire at the rate of 750 rounds per minute. The rifle is chambered for the 7.62-mm NATO cartridge and is

Student Notes:

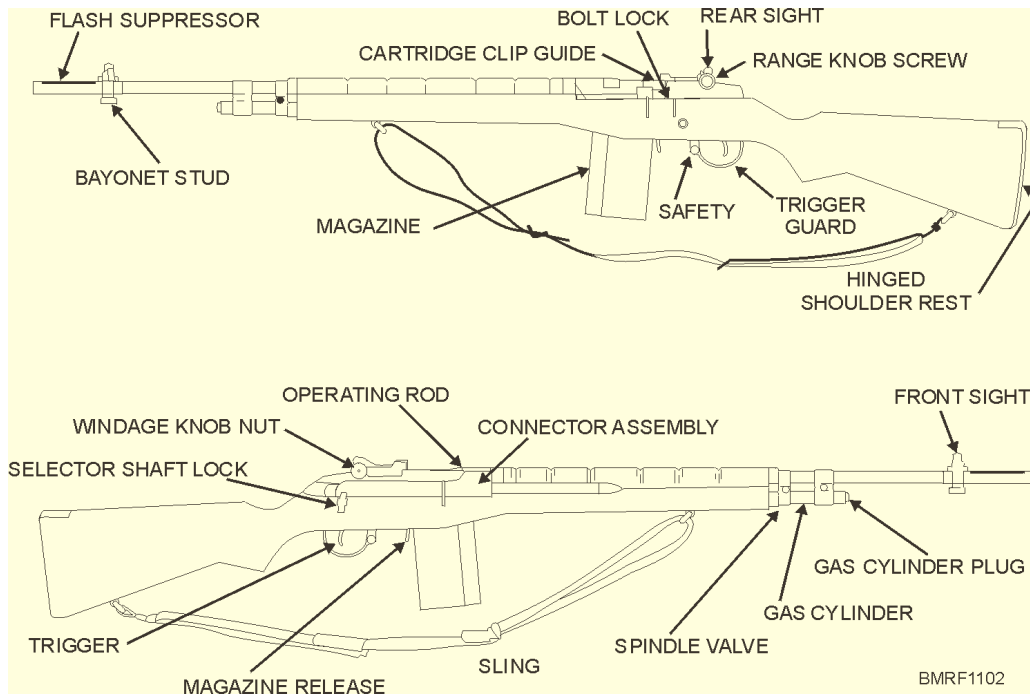

Figure 11-2.—The 7.62-mm M14 rifle.

designed to accommodate a 20-round magazine, the M76 grenade launcher, and the M6 bayonet.

The overall length of the rifle (with a flash suppressor) is 41.31 inches. The weapon has a muzzle velocity of 2,800 feet per second and a maximum range of 4,075 yards. Empty, the rifle weighs about 9 pounds. Fully loaded and ready to fire, the rifle weighs about 11 pounds.

THE M16A1/A2 RIFLE

Learning Objectives: When you finish this chapter, you will be able to—

- Identify the differences between the M16A1 and M16A2 rifles.
- Recognize procedures to load and unload the magazine.
- Identify procedures for cleaning and maintaining the M16A1 and M16A2 rifles.

The M16A1 and the M16A2 rifles (fig. 11-3 and fig. 11-4) are magazine-fed, gas-operated shoulder weapons. They are chambered for a 5.56-mm (about

.22-caliber) cartridge. The magazine has a capacity of 20 or 30 rounds and may be loaded with any amount, up to capacity. The caliber may seem small, but the bullet has a muzzle velocity of more than 3,000 feet per second and a muzzle energy of more than 13,000 foot-pounds. A forward assist assembly, located on the right rear of the upper receiver, permits the operator to ensure the bolt is locked in the forward position. They have a maximum effective range of 460 meters.

DIFFERENCE BETWEEN THE M16A1 AND THE M16A2

The steps you take when field-stripping and cleaning the M16A1 and M16A2 weapons are basically the same. However, there are some major differences between the two weapons. These differences include the barrel, sights, selector assembly, ammunition, and hand guards of the two rifles.

WARNING

Ensure you are using the proper ammunition for the M16A1 and the M16A2. Improper use may cause serious damage.

Student Notes:

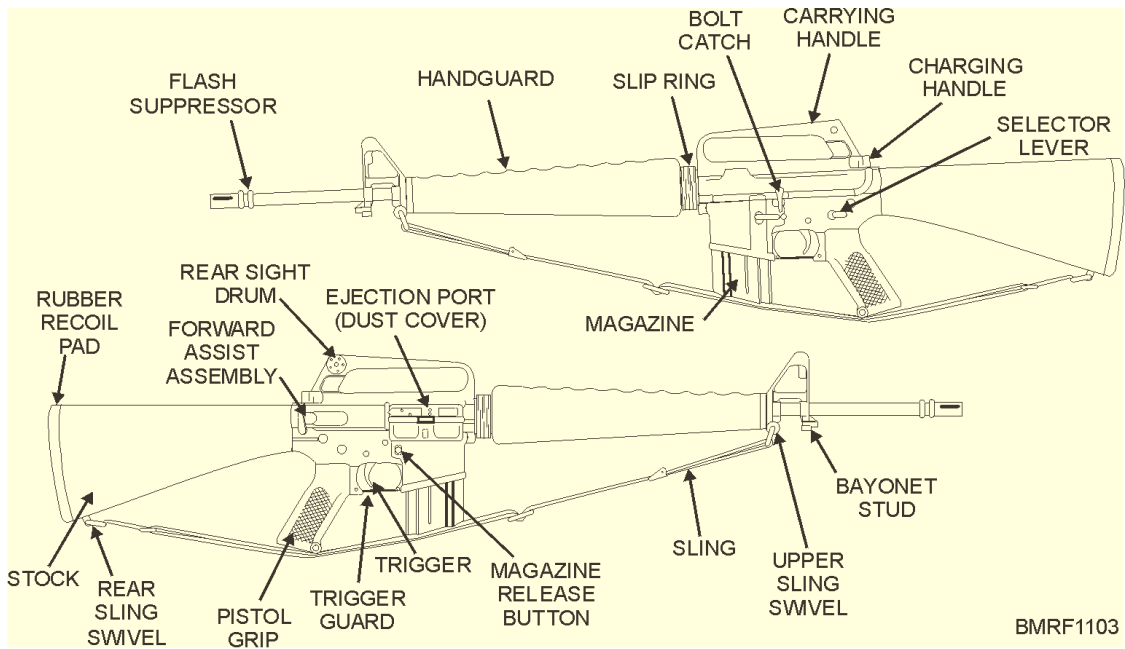

Figure 11-3.—M16A1 service rifle, 5.56 mm, left and right side views.

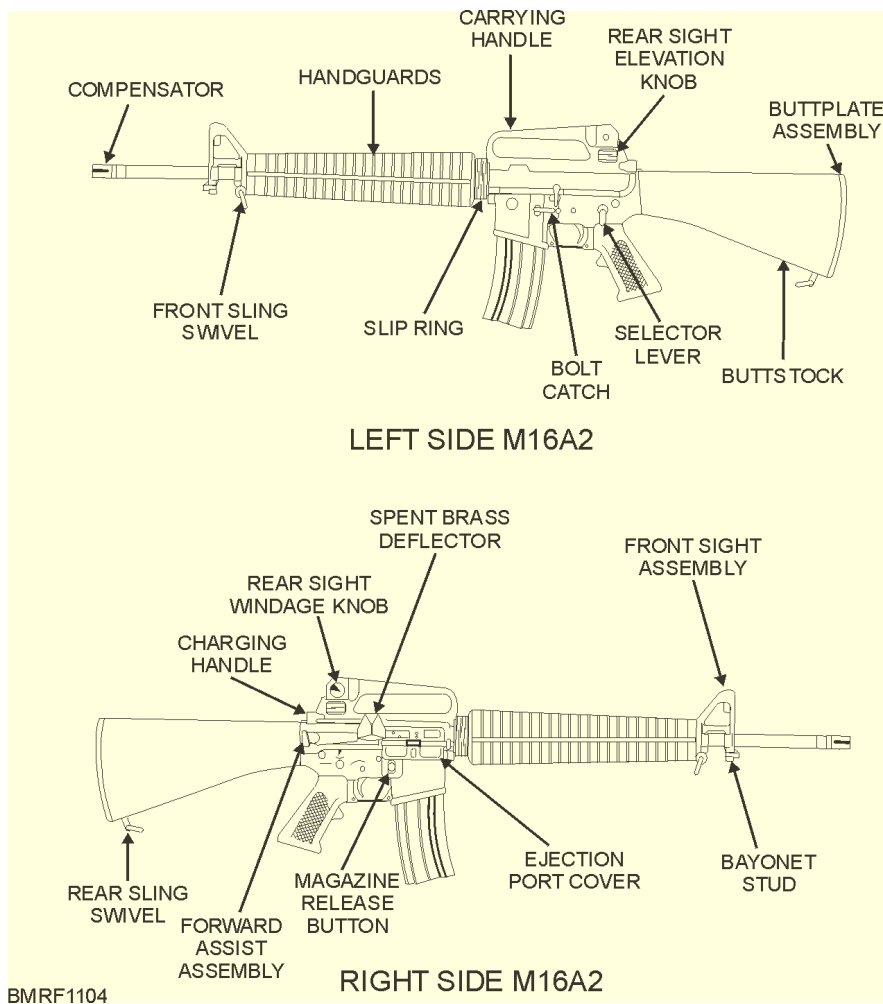

Figure 11-4.—M16A2 service rifle, 5.56 mm, left and right side views.

COMPONENT	M16A1	M16A2
Barrel	Lighter barrel because of ammunition fired	Heavier barrel because of ammunition fired
Sights	Rear sight uses a windage drum for windage (fig. 11-5) Front sight is same as the M16A2 (fig.11-6)	Rear sight is adjusted by means of a windage knob for windage and an elevation knob for elevation (fig.11-7)
Selector assembly	Has semiautomatic or fully automatic features	Has a semiautomatic or burst (three rounds) feature
Ammunition	Fires a 5.56-mm round and a 62-grain NATO round	Fires a 5.56-mm round and a 62-grain NATO round
Hand guards		Round and ridged, making them stronger and easier to grip than the M16A1 hand guards. They are also interchangeable.

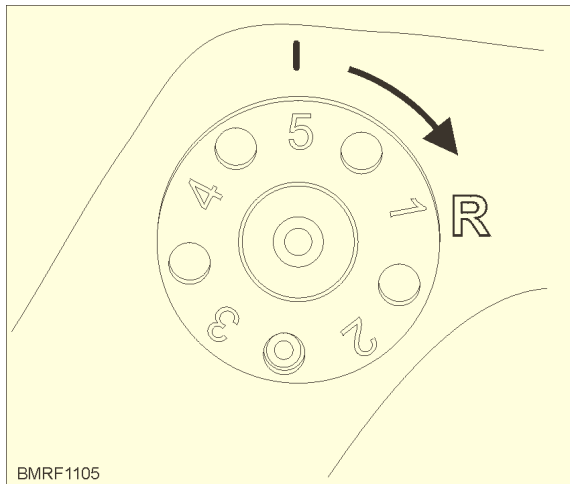

Figure 11-5.—M16A1 windage drum.

CLEARING THE RIFLE

The following maintenance procedures (clearing, field-stripping, assembling, etc.) for the M16 service rifles are written for the right-handed Sailor. The left-handed Sailor can reverse the hand directions for these procedures for the M16

NOTE

Unless specifically stated otherwise, the following discussion of the M16 rifle applies equally to both the M16A1 and M16A2.

The first precaution you should take in handling any weapon is to make it safe by clearing it. To clear the M16 rifle, place the butt against the right thigh and proceed as follows:

1. Point the selector lever toward SAFE (fig. 11-8, view A). If the weapon is not cocked, the selector lever cannot be pointed toward SAFE. If that is the case, do

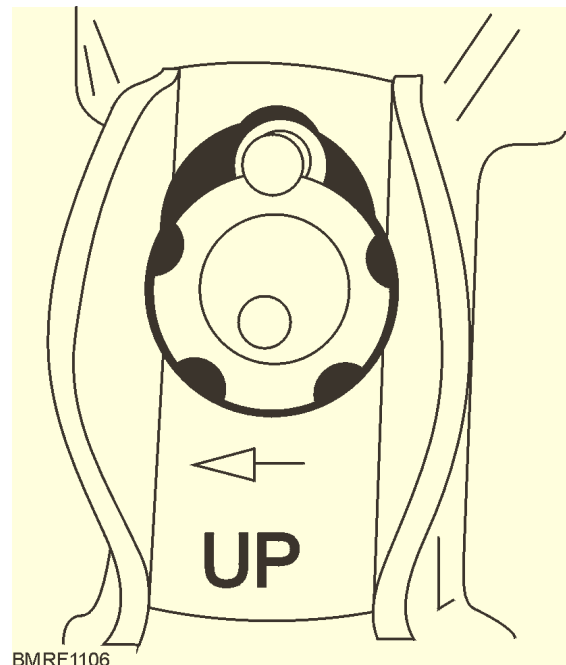

Figure 11-6.—Front sight for the M16A1 and the M16A2 rifle.

Student Notes:

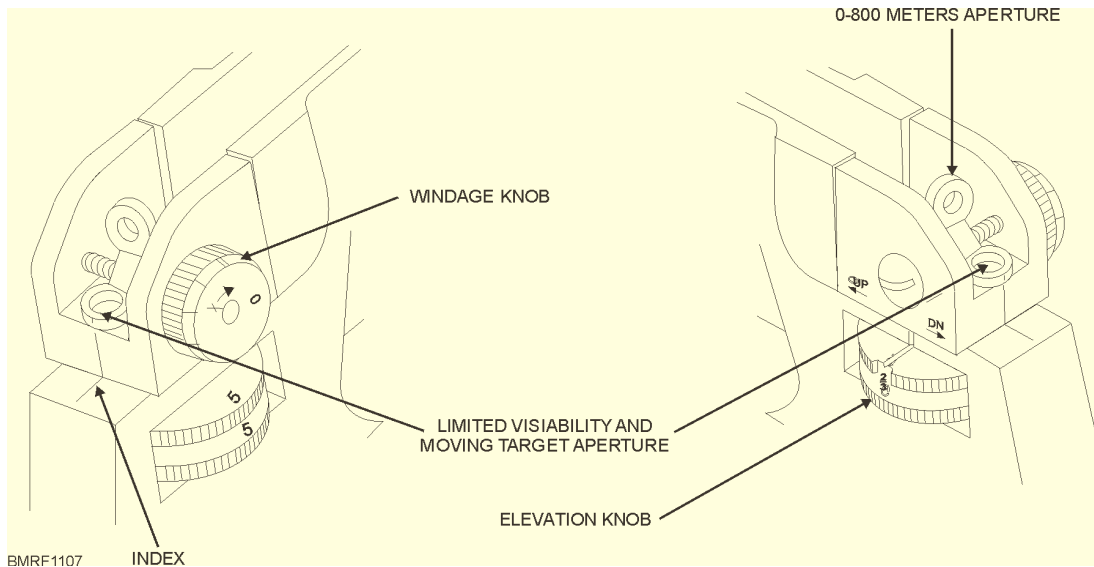

Figure 11-7.—M16A2 rear sight.

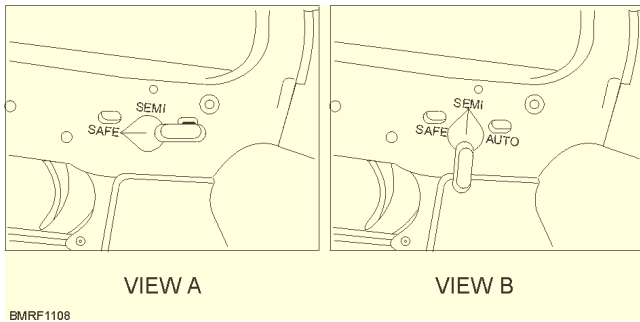

Figure 11-8.—Selector lever pointing to SAFE.

not cock the weapon at this time; instead, go on to the next step in clearing.

2. Remove the magazine (fig. 11-9). Grasp the magazine with the left hand (fingers curled around the front of the magazine, thumb placed on the magazine catch button). Use your right hand and apply pressure on the magazine catch button with the thumb and pull the magazine straight out of the weapon.

3. Lock the bolt open (figs. 11-10 and 11-11). Grasp the charging handle with the thumb and forefinger of the right hand, depress the charging handle, latch it with the right thumb, and pull to the rear (fig. 11-10). When the bolt is fully rearward, press the bottom of the bolt catch with the thumb or forefinger of the left hand (fig. 11-11). Allow the bolt to move slowly

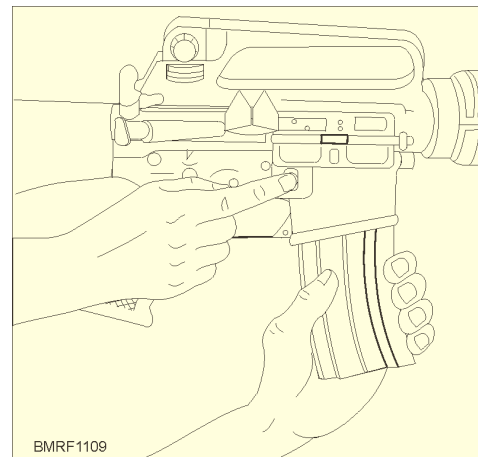

Figure 11-9.—Removing the magazine.

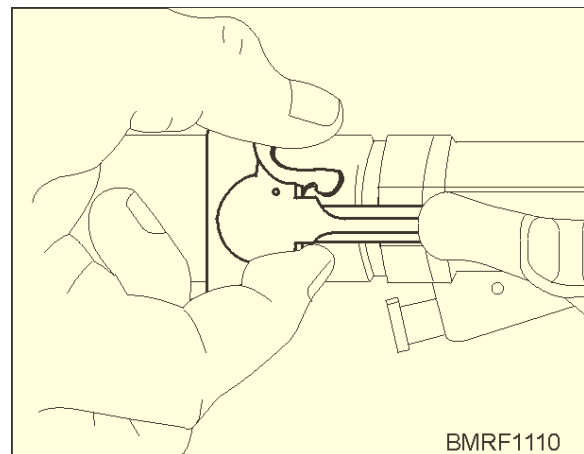

Figure 11-10.—Pulling the charging handle rearward.

Student Notes:

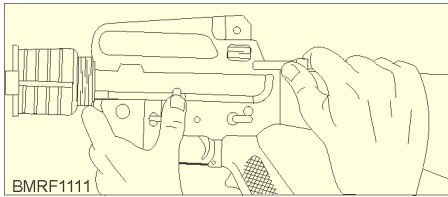

Figure 11-11.—Locking the bolt open.

forward until it engages the bolt catch, and return the charging handle to its forward position.

4. Inspect the receiver and chamber of the weapon by looking through the ejection port to ensure these spaces contain no ammunition.

5. Check the selector lever to ensure it points toward SAFE; then allow the bolt to go forward by depressing the upper portion of the bolt catch.

CAUTION

The selector must be on SAFE to prevent damage to the automatic sear during assembly and disassembly.

FIELD-STRIPPING THE RIFLE

Before you can field-strip a rifle, you must be qualified to do so. **You will use instructions when you actually field-strip a rifle.** Follow the procedures in the instruction that deals with the weapon that you are field stripping.

LOADING THE MAGAZINE

A magazine can come in either a 20- or 30-round capacity and may be loaded with any amount up to that capacity. The magazine follower has a raised portion generally resembling the outline of a cartridge. Cartridges are loaded into the magazine so the tips of the bullets point in the same direction as the raised portion of the follower (fig. 11-12).

CAUTION

Do not load or attempt to load more rounds than what the magazine was designed for. Overloading deforms the lips of the magazine and can cause malfunctions.



Figure 11-12.—Loading cartridges into the magazine, 20 -round capacity.

UNLOADING THE MAGAZINE

To prevent damage to the lips of the magazine, you should remove the ammunition in the following manner:

1. Hold the magazine in your left hand with the open end away from your body and with the nose of the cartridge down (fig. 11-13, view A).

2. Depress the center of the second round in the magazine using the nose of the cartridge, allowing the first round to drop out of the magazine (fig. 11-13, view B). Repeat this procedure until you remove all the rounds from the magazine except the last one.

3. Use the nose of the cartridge to depress the follower to remove the last round, allowing the last round to drop out of the magazine (fig. 11-13, view C).

LOADING THE RIFLE

With the hammer cocked, place the selector lever on SAFE. (Refer to figure 11-8, view A.) Notice that you can't place the selector lever on SAFE unless the rifle is cocked. You may insert the magazine with the bolt and bolt carrier open or closed; however, you should learn to load with the bolt open. Loading with the bolt open reduces the possibility of first round stoppage and saves the time needed to pull the charging handle to the rear.

Hold the stock of the rifle under your right arm with your right hand. Grasp the pistol grip; then point the

Student Notes:

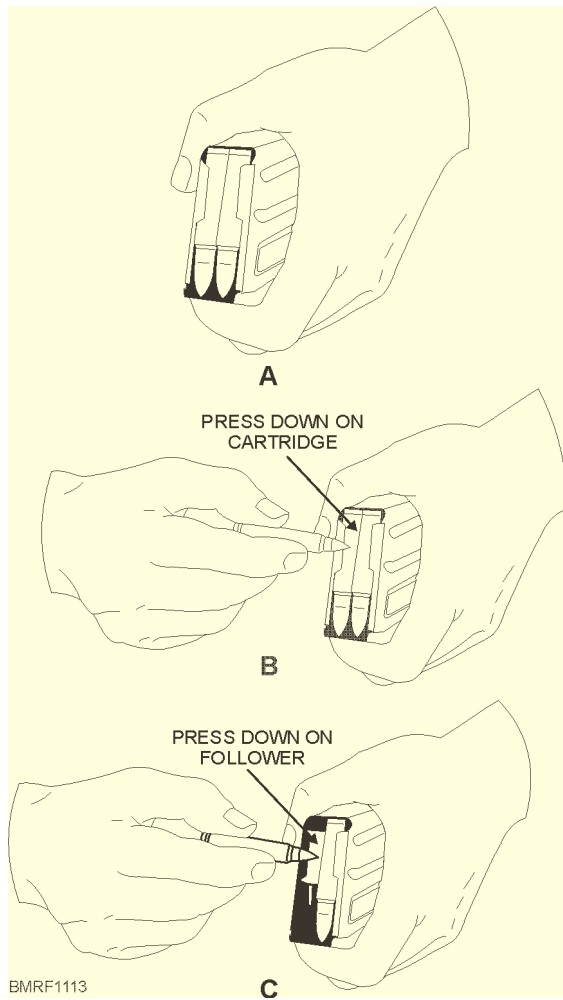

Figure 11-13.—Unloading the magazine with the nose of a cartridge.

muzzle in a safe direction. With your left hand, insert the loaded magazine into the magazine housing. Push upward until the magazine catch engages and holds the magazine. Rap the base of the magazine sharply with the heel of your hand to ensure positive retention. If the action is open, release the bolt by depressing the upper portion of the bolt catch with the thumb of your left hand, allowing the action to close, chambering the round. If the action is closed when the magazine is inserted, pull the charging handle fully to the rear with your right hand and release it. (Refer to figure 11-10.)

WARNING

Don't *ride* the charging handle forward with the right hand. If the charging handle is eased

forward from the open position, the bolt may fail to lock. If the bolt fails to go fully forward, use the bolt closure forward assist assembly (fig. 11-4) with the heel of your right hand. The rifle is now loaded and is ready to fire when you place the selector lever in the automatic or semiautomatic position. If it is not ready to fire, make sure the selector lever is on SAFE.

After the last round has been fired, the bolt catch holds the bolt carrier to the rear. To change the magazine for reloading, press the magazine catch button and remove the empty magazine from the weapon.

FIRING THE RIFLE

The rifle fires semiautomatic or burst (automatic for the M16A1) when you move the selector lever to the desired position. (Refer to figure 11-8.) With the selector lever in the semiautomatic position, the rifle fires one round each time you pull the trigger. With the selector lever in the burst position, the M16A2 fires in short bursts of three rounds. (**NOTE:** The M16A1 rifle fires fully automatically and will continue to fire until the magazine is empty or you release the trigger.) When the rifle is fired in either SEMI or BURST or AUTOMATIC, the bolt locks in the open position when the last round from the magazine has been fired.

UNLOADING AND CLEARING THE RIFLE

As you read this section, refer back to figures 11-8, 11-9, 11-10, and 11-11. To unload the rifle and make it safe, place the selector lever on the SAFE position (fig. 11-8); and remove the magazine by pressing the magazine release button (fig. 11-9). Pull the charging handle to the rear (fig. 11-10), ejecting any round from the chamber. Inspect the chamber and receiver to ensure that it is clear. Releasing the charging handle will allow the bolt to close. To keep the bolt open, depress the lower portion of the bolt catch before returning the charging handle forward (fig. 11-11). The rifle is clear only when the following conditions exist:

- No case or round is in the chamber.
- The magazine is out.

Student Notes:

- The bolt carrier is to the rear.
- The selector lever is on the SAFE position.

CARING AND CLEANING OF THE RIFLE AND AMMUNITION

A clean, properly lubricated and maintained rifle that is loaded with clean ammunition will fire when needed. To keep the rifle in good condition,

you need to take care of it and clean it. Under bad weather conditions, some key parts may need care and cleaning several times a day. The cleaning material (fig. 11-14) used for the care of the rifle is carried in the rifle stock. Special attention must be given to the barrel bore and chamber, bolt carrier group, upper receiver group, lower receiver group, and the ammunition magazines.

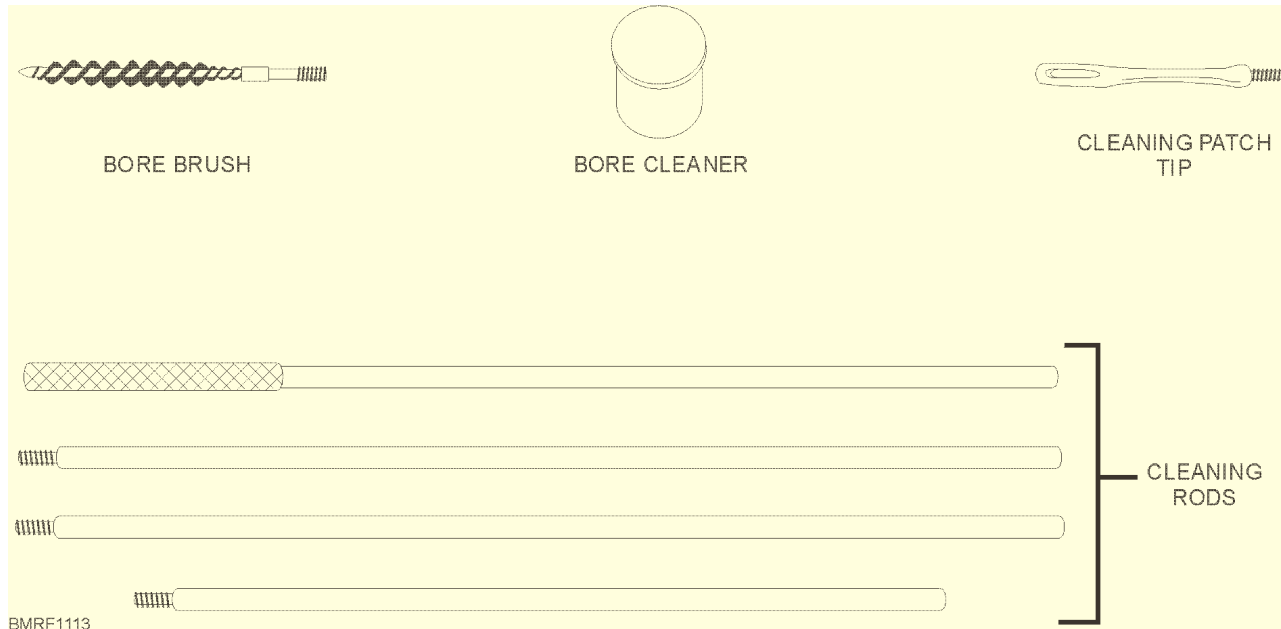

Figure 11-14.—M16A1 and M16A2 rifle cleaning material.

PART	ACTION
Barrel bore and chamber	<ol style="list-style-type: none"> 1. Dip a bore brush in the bore cleaner; then brush from the chamber to the muzzle, using straight-through strokes. Don't reverse the brush while it is in the bore: it may jam. A jammed brush is hard to remove, and removing the brush might damage the bore. 2. Dip the brush in bore cleaner; then clean the chamber with the bore brush. 3. Replace the bore brush with a slotted cleaning patch tip, and push the dry patches through the bore and chamber until they come out clean. 4. After you clean the bore, lightly lubricate the bore and chamber to prevent corrosion and pitting. Use the recommended lubricant on a patch. 5. Lightly lubricate the lugs in the barrel extension.

Student Notes:

PART	ACTION
Bolt carrier group	<ol style="list-style-type: none"> 1. Dip the bore brush in the bore cleaner, and clean the inside of the carrier key. 2. Dry with a pipe cleaner 3. Clean the locking lugs, bolt, extractor ejector, and bolt rings with the bore brush. 4. Remove any accumulation of dirt, carbon, or oil from the firing pin and the external and internal surfaces of the bolt and bolt carrier. 5. Wipe all parts dry; then lubricate them with the recommended lubricant.
Upper receiver group	<ol style="list-style-type: none"> 1. Coat the bore brush or a swab with bore cleaner; then remove the powder fouling collected on the group. 2. Clean the protruding gas tube inside and outside. 3. After cleaning these components, wipe them dry. 4. Apply a light coat of the recommended lubricant.
Lower receiver group	<ol style="list-style-type: none"> 1. Coat the bore brush or a swab with bore cleaner; then remove dirt, carbon, and sand from the lower receiver group. 2. Dry and apply a light coat of the recommended lubricant.
Ammunition magazines	<ol style="list-style-type: none"> 1. After removing all cartridges from the magazine, depress the spring steel lock band on the bottom of the magazine, using the nose of a cartridge. 2. Slide the base until it is free of the tabs, and remove it from the magazine body. 3. Remove the magazine spring and follower, but do not remove the follower from the spring. 4. Clean the exterior and interior of the magazine with a dry rag or swab. 5. Apply a light coat of the recommended lubricant to the magazine spring only; otherwise, keep the magazine dry. <ul style="list-style-type: none"> ● Assemble the magazine in reverse order and test it to ensure that the follower is free to move without binding. ● If the magazine and the ammunition in it gets wet, be sure to wipe them dry as soon as possible. ● When left wet, both the magazine and the ammunition can become corroded and are dangerous to use. ● Remember not to use oil or grease on any cartridge. If you do this, injurious abrasives can collect in the weapon or produce excessive and hazardous chamber pressures when the weapon is fired. Whenever practical, ammunition should be stored under cover. This applies particularly to tracer ammunition.

Student Notes:

REVIEW 2 QUESTIONS

- Q1. What type of ammo is the M-14 rifle chambered to fire?
- Q2. When fully loaded, the M-14 weighs _____.
- Q3. Identify the following rifle components as either M16A1 or M16A2.

Component	Rifle
a. Has a lighter barrel because of the ammunition fired	
b. Rear sights are adjusted by means of a windage knob and elevation knob	
c. Has a semiautomatic or burst feature	
d. Fires a 5.56-mm round and a 62-grain round	

- Q4. What is the first step in cleaning the M16 rifle?
- Q5. How many rounds does an M16 rifle carry?
- Q6. When loading the M16 rifle, why shouldn't you ride the charging handle forward?
- Q7. When the selector is set for burst, how many rounds will the M16A2 fire?

- Q8. List the conditions that must exist to consider the M16 rifle clear.
- -
 -
 -
- Q9. Where are the cleaning materials for the M16 stored?

REVOLVERS AND SERVICE PISTOLS

Learning Objectives: When you finish this chapter, you will be able to—

- Recognize the operating characteristics of the .38-caliber revolver.
- Recognize the procedures to follow when loading and unloading the magazine, and unloading and cleaning the .45-caliber pistol.
- Identify the procedures for cleaning and maintaining the .45-caliber pistol.
- Identify the safety devices of the 9mm caliber pistol.
- Recognize the procedures to follow when loading and unloading the 9mm pistol.

NOTE

The .38-caliber revolver and the .45-caliber service pistol have been replaced by the 9mm pistol. However, small units may still carry these revolvers and pistols in their allowance.

Student Notes:

THE .38-CALIBER REVOLVER

The .38-caliber revolver is a cylinder-loading, single- or a double-action, manually operated hand weapon (fig. 11-15). Several barrel lengths and weights are available.

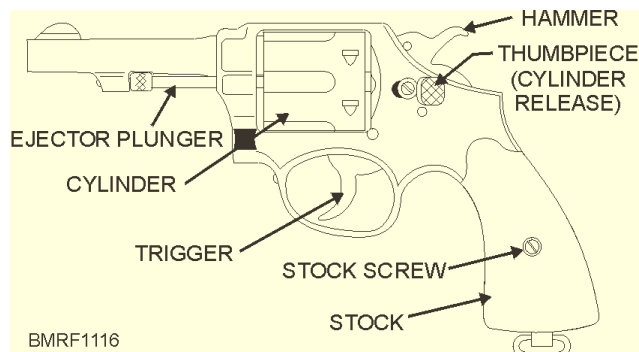

Figure 11-15.—The .38-caliber revolver.

THE .45-CALIBER SERVICE PISTOL

The .45-caliber service pistol (fig. 11-16) is an individual weapon intended for use in close combat. The .45-caliber pistol is a semiautomatic, recoil-operated, magazine-fed hand weapon. The pistol fires one round each time the trigger is squeezed. The pistol can be carried in either a hip or shoulder holster.

The magazine holds seven cartridges. The forward movement of the slide strips the upper cartridge from the magazine into the chamber. After the last cartridge from the magazine has been fired, the slide remains in the rear.

Only your ability to change magazines, aim, and squeeze the trigger rapidly limits the rate of fire of the .45-caliber service pistol.

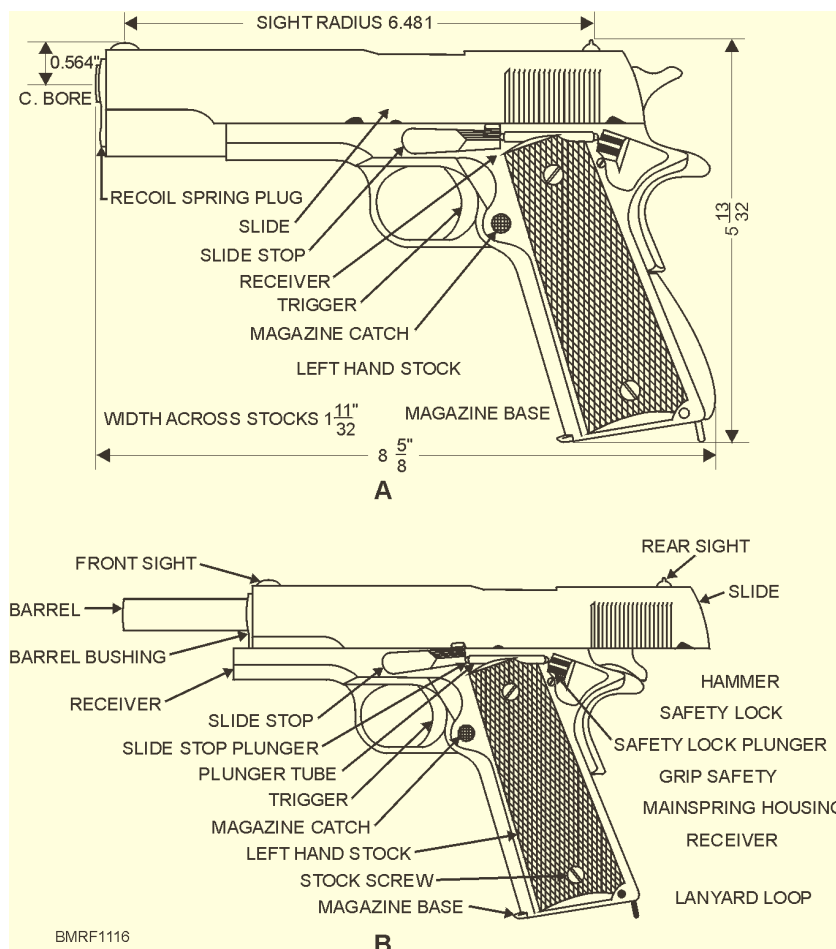

Figure 11-16.—.45-caliber semiautomatic service pistol. (A) Assembled; (B) Sectional view in recoil position.

Student Notes:

The pistol is 8 5/8 inches in length and weighs 3 pounds fully loaded, with a maximum range of 1,500 yards, and a maximum effective range of 50 yards.

THE 9MM SERVICE PISTOL

In 1985, the armed forces selected a 9mm pistol to replace the .45-caliber pistol. The pistol selected is a single- or double-action semiautomatic hand weapon. As soon as the pistol is fired, either in single or double action, the slide automatically comes back and cocks the hammer. To fire the pistol again, all you have to do is pull the trigger. The 9mm pistol has a large magazine capacity—it can hold 15 rounds in the magazine. Slots in the magazine help the user know the number of rounds that remain.

Description and Technical Data

As you know, the 9mm service pistol is a semi-automatic, magazine-fed, recoil operated, double-action pistol. The pistol fires one round each time the trigger is pulled. The energy needed to operate the pistol comes from the recoil, which is created by the rearward force of expanding gases of a fired round. The double-action feature lets you fire a weapon when the hammer is in the forward position, the safety is in the fire position, and the trigger is pulled. The magazine holds 15 cartridges. When the last cartridge from the magazine is fired, the slide remains locked to the rear. Look at the following chart for the technical data of the 9MM service pistol.

Safety Devices

The 9mm service pistol is equipped with three types of safety features—the ambidextrous slide safety, the firing pin block, and the half cock notch.

AMBIDEXTROUS SAFETY.—This safety allows for safe operation of the pistol by both right- and left-handed users. It lowers the hammer safely without causing an accidental discharge. When the hammer is cocked, it may be safely lowered by moving the safety to the safe (down) position. When the safety is in the fire (up) position, a red dot will be visible indicating that the pistol should be handled with caution (**red you're dead**).

COMPONENT	TECHNICAL DATA
Caliber	9 x 9mm (9mm NATO)
Diameter of bore	.356 in.
Length	217 mm (8.54 in.)
Width	38 mm (1.50 in.)
Height	140 mm (5.51 in.)
Weight with 15-round magazine	1,134 g (2.50 lb.)
Weight with empty magazine	960 g (2.12 lb.)
Barrel length	125 mm (4.92 in.)
Muzzle velocity	375 m/sec (1,230 ft/sec)
Maximum effective range	50 mm (45.7 yd)
Cyclic rate of fire	1,100 rpm
Trigger pull	4 to 6.5 lb single action and 7.5 to 16.6 lb double action

FIRING PIN BLOCK.—This safety prevents any motion of the firing pin and is only overcome by pulling on the trigger. Both the firing pin and the firing pin block have a notch cut into them. The firing pin block remains in the firing pin notch and prevents any motion of the firing pin. When you pull the trigger, the firing pin block is pushed upward and aligns its notch with the firing pin so that the firing pin can move forward to strike the primer of a round.

HALF COCK NOTCH.—This safety prevents accidental discharge. The half cock notch is located on the hammer. If a cocked hammer should fall forward because of a mechanical failure, the half cock notch would catch on the sear before the hammer strikes the firing pin and prevent an accidental discharge of the pistol.

Loading

The 9mm service pistol incorporates single- and double-action modes of fire. With the safety in the **FIRE** position, in the double-action mode, squeezing

Student Notes:

the trigger will automatically cock and fire the pistol. Always keep your finger away from the trigger unless you intend to fire. The safety should be in the down position (the red dot not visible), which indicates that the pistol is in a safe condition before loading. With the pistol pointing in a safe direction and the slide in its forward position, follow the steps listed below.

STEP	ACTION
1	Insert a loaded magazine into the magazine well of the pistol until you hear a click. This ensures a proper catch engagement.
2	Grasp the serrated portion of the slide with the nonshooting hand (fig. 11-17).
3	Pull the slide all the way to the rear (fig. 11-18).
4	Release the slide. This will strip a cartridge from the magazine and chamber a round (fig. 11-19).

WARNING

Although rare, it is possible that the safety may become disengaged during the loading

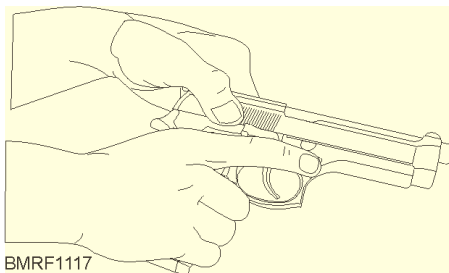

Figure 11-17.—Grasping the serrations of the slide.

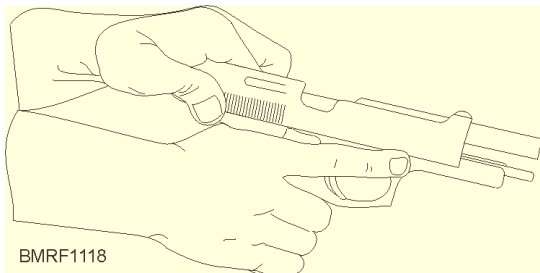

Figure 11-18.—Pulling the slide to the rear.

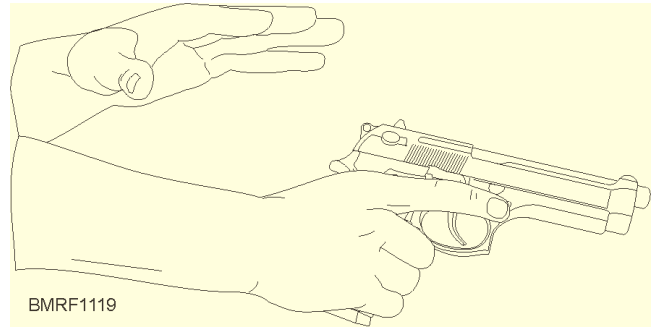

Figure 11-19.—Releasing the slide.

procedure. Make sure the safety is on after loading.

Unloading

To unload the 9MM service pistol, follow the steps listed below.

STEP	ACTION
1	Place the safety in the safe position.
2	Depress the magazine release button to remove the magazine from the pistol.
3	With the pistol pointing in a safe direction, grasp the slide serrations and fully retract the slide to remove the chambered cartridge.
4	Use the right thumb and push upward on the slide stop to lock the slide to the rear, and visually inspect the chamber to ensure that it is empty.

Unloading the Magazine

To unload the magazine, hold the magazine using one hand, with the front end forward. With your thumb, press firmly on the cartridge rim and push forward. Repeat this procedure until the magazine is empty.

REVIEW 3 QUESTIONS

- Q1. How many rounds will a .45-caliber pistol magazine hold?

Student Notes:

NOTE

Q2. The .45 caliber pistol was designed to be used as _____.

Q3. List the three safety features of the 9mm service pistol.

a.

b.

c.

Q4. You are loading your pistol. The safety should be in what position?

Make certain you load the M870 with the proper ammunition. For example, many people have been injured by a shotgun loaded with a smaller gauge shell. This smaller shell goes part way down the barrel and cannot be fired. The user thinks a misfire has occurred and chambers the proper size shell. Firing the weapon causes the gun to explode because the smaller shell is an obstruction. Serious injury or death could occur.

SHOTGUNS

Learning Objective: When you finish this chapter, you will be able to—

- Identify the safety practices to follow when using shotguns.

Shotguns (fig. 11-20) are being used by the Navy in security guard work. Shotguns are the weapons of choice for short-range work, which includes the requirement to protect vital nuclear propulsion systems and nuclear weapons. The advantage of shotguns over pistols/revolvers is that sight alignment is not so critical. Each trigger pull of a shotgun expels anywhere from nine to hundreds of projectiles (shot). These projectiles cover a wide area. The characteristics of the M870 shotgun are shown in the following chart:

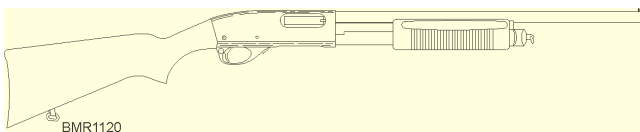

Figure 11-20.—M870 shotgun.

COMPONENT	CHARACTERISTIC
M870 shotgun	A manually operated, magazine-fed (tubular), pump-action shoulder weapon.
Length—Overall	39 inches
Barrel	20 inches
Ammunition	Four rounds of 12-gauge, 2 ¾ inch in the magazine. Normal ammunition issue is 12 gauge, 00 buck
Crossbolt Safety	

REVIEW 4 QUESTION

Q1. What advantage does a shotgun have over other firearms?

MARKSMANSHIP

Learning Objective: When you finish this chapter, you will be able to—

- Recognize the firing techniques for rifles and pistols.
- Identify the shooting positions.

Marksmanship training gives you proper information and instruction on how to be a safe and effective shooter. Good shooting, whether on the firing range or in combat, depends on your knowledge and use of basic marksmanship principles. These principles are interrelated and must be practiced each time you fire a shot.

Student Notes:

FIRING TECHNIQUES—RIFLE

The most important factors for you to remember about firing a rifle are sight alignment and achieving a correct aiming point. Together they make up the sight picture.

Sight Alignment

Sight alignment involves looking through the rear sight aperture, focusing the eye on the front sight post (or blade), and centering the front sight post exactly in the rear sight aperture, both vertically and horizontally. The top of the front sight is level with the horizontal center line of the rear sight, and the body of the front sight is centered between the rear sight aperture (fig. 11-21).

REAR SIGHT.—When you are in different firing positions (standing, kneeling, or sitting), your aiming eye is at a slightly different distance from the rear sight. This distance is referred to as *eye relief*. Eye relief makes the opening (peep) of the rear sight appear larger or smaller, depending on the firing position. **Regardless of the apparent size of the rear sight opening, you must align the front sight in the center of the opening.**

It is important to keep your eye the same distance from the peep sight in any particular firing position. To ensure this distance is always the same, you must hold the rifle in the same exact location for each shot. This location is commonly called the *spot weld or anchor*. There are several tricks shooters use to help maintain this distance. For example, you can place a small piece

of tape on the stock of the rifle where it touches the cheek. In this way, you can feel whether your cheek has the proper *eye relief*.

FRONT SIGHT.—The front sight always appears to be the same size. However, depending on the distance your eye is from the rear sight, more or less of the front sight may be visible in the sight picture. The front sight, not the target, is the point of focus for the eye. As such, the front sight will be sharp and distinct in outline. For this reason, keep the front sight square, level, and blackened.

AIMING POINT.—The aiming point is the point on the target where the sights of the weapon are brought to bear. The correct aiming point is at 6 o'clock; that is, the bottom of the bull's-eye of a type "A" target (fig. 11-22) or the silhouette of a type "D" target (fig. 11-23). Any location on the target face is always given relative to a similar position on a clock face regardless of the target shape. Therefore, a vertical line in the exact center of the target would be described as running from 12 o'clock (top) to 6 o'clock (bottom).

SIGHT PICTURE.—To obtain the correct sight picture, you need to align the rear sight, the front sight, and the bull's-eye (figs. 11-22 and 11-23). Each of these three elements affects the sight picture. As you can see from figure 11-24, any error in sight alignment will increase as the range increases. An error in the aiming point remains constant as the range increases.

At close ranges, the bull's-eye or silhouette appears larger in relation to the front sight than it will at longer

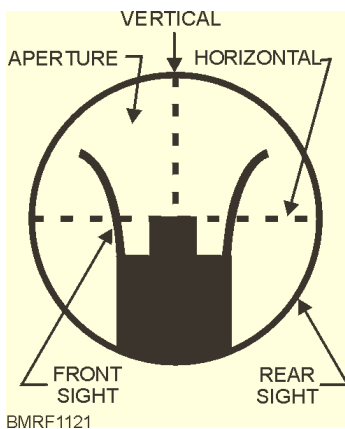

Figure 11-21.—Proper sight alignment.

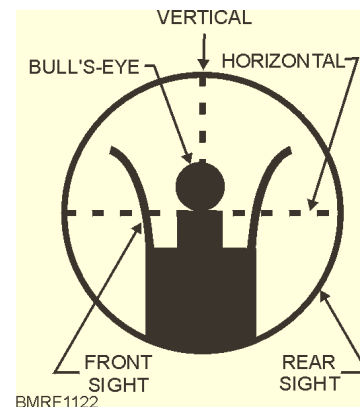

Figure 11-22.—6 o'clock sight picture held on "A" target at a range of 200 yards.

Student Notes:

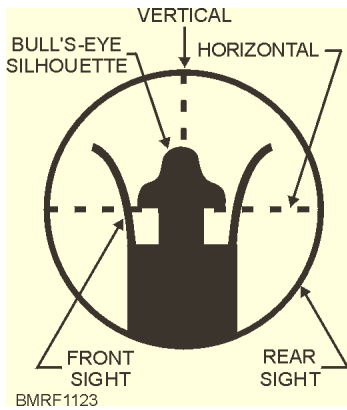

Figure 11-23.—6 o'clock sight picture held on a "D" target at a range of 200 yards.

ranges. This means that the sight picture will vary not only from one firing position to another but also from one firing line to another (fig. 11-25).

TRAINING.—You will receive training in aiming along with the position and trigger squeeze before actually firing on the rifle range. You do this by aiming at a series of small bull's-eyes at least 20 feet away on a *dry firing range*; this training is known as *snapping in*.

BLACKENING SIGHTS.—You should blacken the sights during sighting and aiming exercises to help eliminate light reflection or glare. Blacken all sights, both front and rear, on the base of the receiver and the

top of the barrel. Usually, sights are blackened by using a smudge pot, carbide lamp, oily patch, candle, cigarette lighter, or ordinary match. Be sure to remove all oil from the sight before blackening it.

Shooting Positions

For the best results in rifle shooting, you need to shoot in the correct shooting position. The better the position, the easier it is to hold the rifle and squeeze the trigger while the sights are properly aligned on the target. However, shooting position **won't** compensate for lack of practice. You may have difficulty in assuming a correct position until sufficient practice has limbered up your muscles. Once your muscles are limber, you will find the positions both comfortable and steady.

A standard qualification course requires you to learn and use three standard positions while shooting—standing, kneeling, and sitting. Experience has proved that these positions produce excellent results with men and women of all physical types.

Once you master the correct positions, you must combine sighting and aiming with your practice. Learn to get into the correct position and align the sights without moving the rifle. If the target isn't properly aligned with the sights, you must move your body

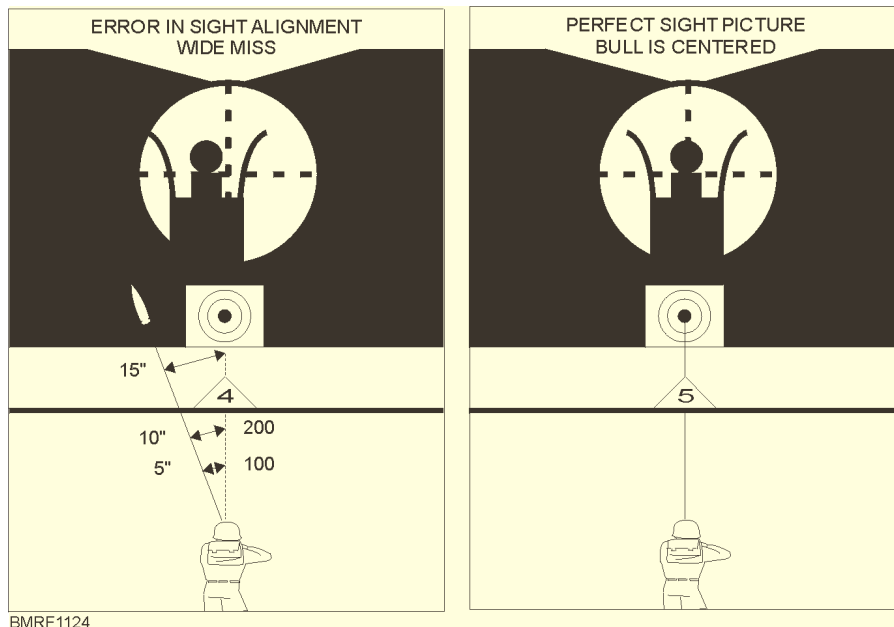

Figure 11-24.—Error in sight alignment increases as range increases.

Student Notes:

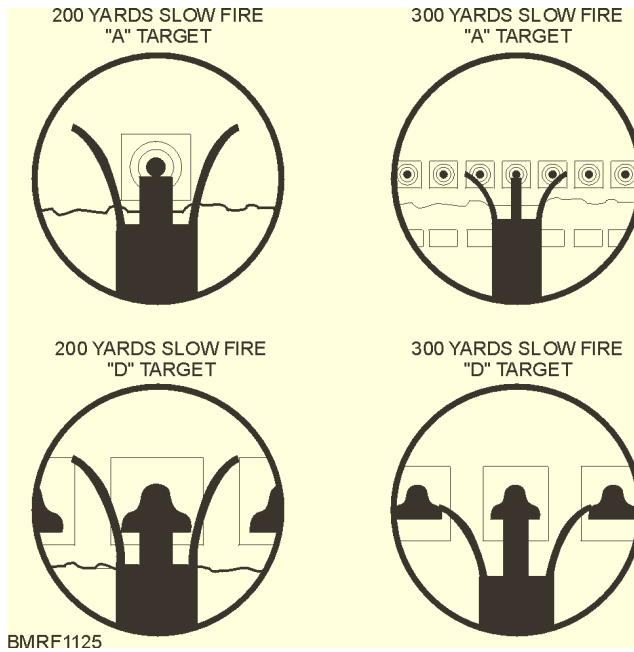

Figure 11-25.—Variation in sight picture for each range of fire.

instead of the rifle until you obtain the proper sight picture.

STANDING (OFF-HAND) POSITION.—The standing position (fig. 11-26) is used to engage surprise targets that appear at close ranges. Normally, you use this position when engaging targets less than 100 yards in range and when you are constantly firing and moving.



BMRF1126

Figure 11-26.—Standing position.

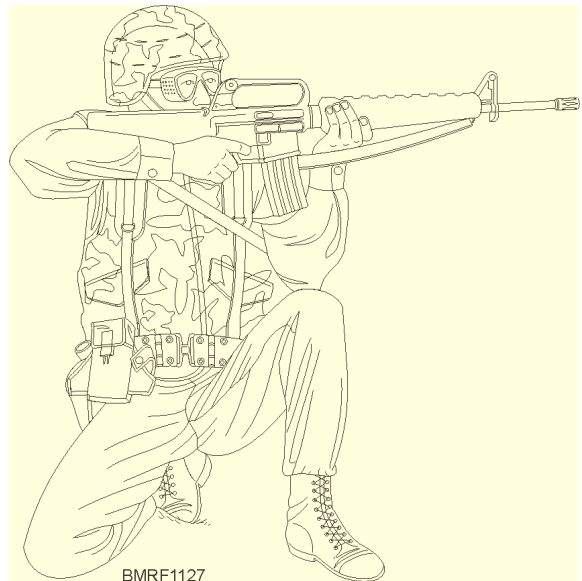

BMRF1127

Figure 11-27.—Kneeling position.

Student Notes:

KNEELING POSITION.—The kneeling position (fig. 11-27) is a natural position that can be assumed quickly. It is suitable for use on level ground or on ground that slopes upward.

SITTING POSITION.—There are three variations of the sitting position:

1. Open leg
2. Cross leg
3. Cross ankle

The position used depends entirely on the shooter. The open-leg position (fig. 11-28) is especially suited

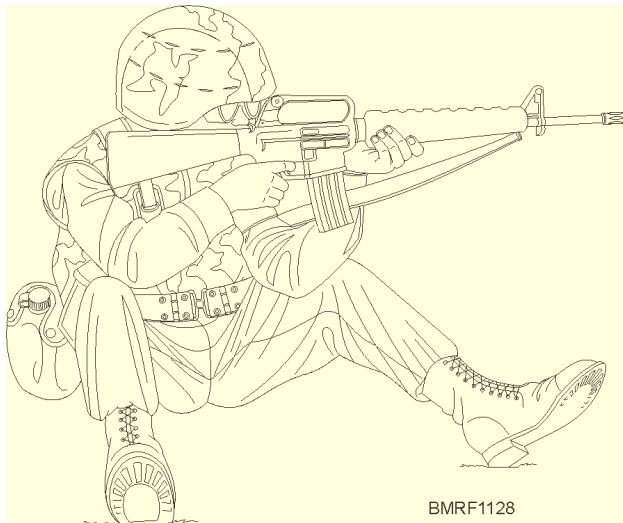

Figure 11-28.—Open-leg position.

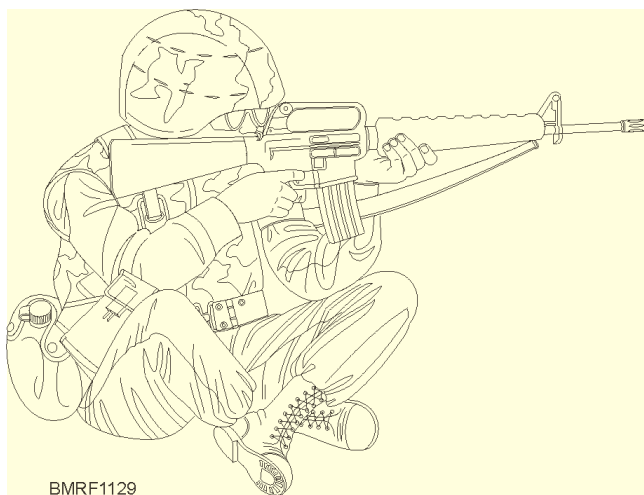

Figure 11-29.—Cross-leg position.

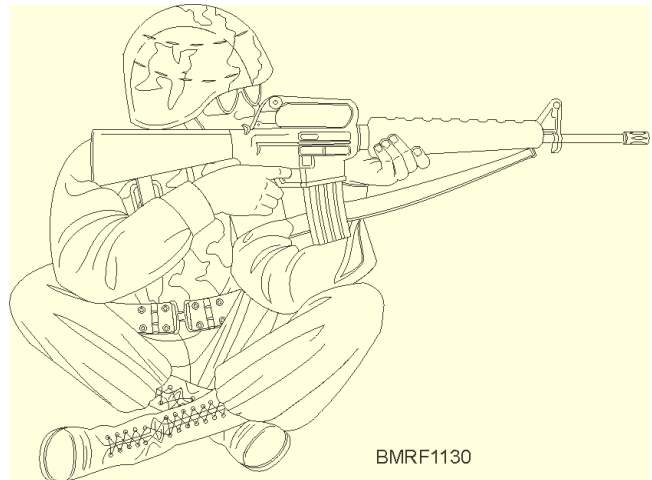

Figure 11-30.—Cross-ankle position.

for use on ground that slopes downward. The other two alternate sitting positions are the cross-leg position (fig. 11-29) and the cross-ankle position (fig. 11-30).

Trigger Control

The most important single factor in marksmanship is trigger control. Everything about your position and aim may be perfect; but if you do not squeeze the trigger properly, your shot will not go where you aimed it.

The key to trigger control is that the trigger must be squeezed smoothly, gradually, and evenly straight to the rear. Any sideward pressure, however slight, applied to the trigger during its rearward movement will likely result in a wide shot. Similarly, upward or downward pressure on the trigger will result in high or low shots. Trigger control can be done as shown in the chart on the following page:

When you fire from the standing position, coordinating the trigger squeeze and proper aim is critical. You must start and continue the squeeze **only** when the front sight is momentarily at rest or is slowly moving in the smallest area of the bull's-eye. Inexperienced shooters usually tend to *snap shoot* in this position; that is, they attempt to complete the trigger action instantly as the front sight moves across the aiming point. This invariably results in jerking the rifle and producing a wild shot.

Student Notes:

Trigger hand	Grasp the stock or pistol grip firmly, but without strain, so the trigger finger has the proper support to overcome trigger weight. An unnatural, straining grasp causes excessive muscle tension in the hand, which results in a tremor that is transmitted to the weapon.
Trigger (index) finger	Make contact with the trigger where the contact produces a movement straight to the rear (usually between the first joint and the tip). (NOTE: The trigger finger must not touch the receiver or rifle.)
Line up the sights and apply pressure on the trigger	Gradually increase the pressure until the hammer releases and the shot fires. (NOTE: If, during this process, the sights drift off the target, interrupt the trigger squeeze but maintain the pressure. When the sight picture is correct, continue the squeeze until you fire the shot.)

B	BREATH	Proper breathing is essential. It helps you relax, steadies your aim, and clears your vision. First, take a normal breath; then release part of it (enough to be comfortable); and hold the remainder. Do not hold your breath for more than 10 seconds before shooting. This may tense your muscles and blur your vision. If you do not shoot during this breathing period, take another normal breath and repeat the procedure.
R	RELAX	You must relax. The more relaxed you are, the better your shot will be.
A	AIM	Concentrate on the proper sight alignment of the correct sight picture. Focus your eye on the front sight post (blade).
S	SLACK	Some rifles have a certain amount of slack in the trigger. Take up this slack before starting your squeeze to the rear to fire. The M16 trigger slack is insignificant, and this step is generally omitted when firing that weapon. Knowing your weapon is important.
S	SQUEEZE	Squeeze the trigger as previously described. If you squeeze it properly, you will not know when the round will fire. This will prevent flinching, caused by anticipation of the shock, or recoil, from the exploding cartridge.

Squeezing the trigger correctly is not as easy as it may appear; the technique must be fully mastered. To help you remember the correct technique, the acronym BRASS was developed (see chart above).

FIRING TECHNIQUES—PISTOL

Good pistol shooting, like rifle shooting, depends on your ability to master and apply certain basic marksmanship skills. You must practice these skills—aiming, position, and trigger squeeze—often. Apply these fundamentals of marksmanship! If your life ever depends on how well and accurately you shoot the pistol, you might walk away alive.

Aiming the Pistol

Aiming the pistol consists of combining proper sight alignment with the correct aiming point to obtain a correct sight picture.

SIGHT ALIGNMENT.—Sight alignment is best defined as placing the front and rear sights into correct alignment with the eye. The top of the front sight is level with the top of the rear sight, and the body of the front sight is centered between the rear sight aperture (fig. 11-31). Correct sight alignment is essential for accuracy because of the short sight radius (about 6 1/2 inches). For example, if a 1/10-inch error is made in aligning the

Student Notes:

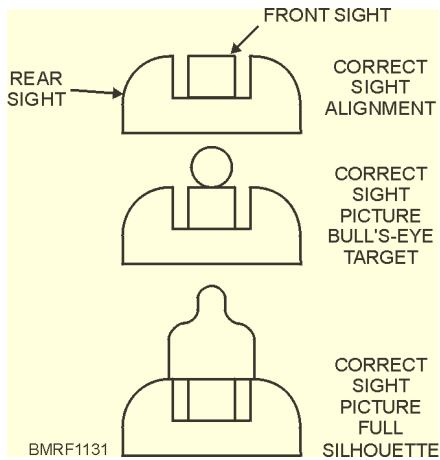

Figure 11-31.—Correct sight alignment and sight picture.

front sight in the rear sight, the bullet will miss the point of aim by almost 15 inches at 25 yards of range.

AIMING POINT.—The correct aiming point, when you fire at a bull’s-eye target at 25 yards, is a 6 o’clock sight picture. At 15 yards, bring the aiming point well up into the black. When you fire at an “E” type of silhouette target, the aiming point is in the center of the target.

CORRECT SIGHT PICTURE.—A sight picture is the pattern of the pistol sights in relation to the target as you aim the pistol. A correct sight picture combines correct sight alignment and correct aiming point (fig. 11-31). When you are aiming, your eye cannot focus simultaneously on three objects (rear sight, front sight, and bull’s-eye) at different ranges. Therefore, the last focus of the eye should always be on the front sight. You will see the front and rear sights sharp and clear, but the bull’s-eye will appear to be a bit hazy.

NOTE

If sight alignment is correct, the bullet will strike the bull’s-eye even if the sight picture is partially off center but still touching the bull’s-eye.

Since it is physically impossible to hold the weapon perfectly still, you must learn to apply trigger squeeze and to maintain correct sight alignment while the weapon is moving around the bull’s-eye. This movement is referred to as the *wobble area*. You must accept this wobble area, or movement, trying to keep it to a minimum.

Position

To position yourself properly for firing the pistol, you need to know how to grip the pistol correctly and how to position your body in relation to the target. Only the standing position will be covered in this section because it is the one used in qualification. However, the pistol can also be fired accurately from the kneeling, standing, and sitting positions. The pistol may be gripped with either a one-hand grip or a two-hand grip.

STANDING POSITION ONE-HAND GRIP.—

To assume the standing position using the one-hand grip (fig. 11-32), face the target squarely and then execute an exaggerated half-left face (about 50°). Spread your feet about shoulder width apart until you’re standing comfortably. Your legs should be straight, but not stiff, and your hips should be level. Extend the index finger of your shooting hand and point it at the target, forming a V with the thumb and forefinger. Adjust your stance until your finger points naturally, without muscle tension, at the center of the target. Pick the pistol up with your other hand and place it in the V of your shooting hand.

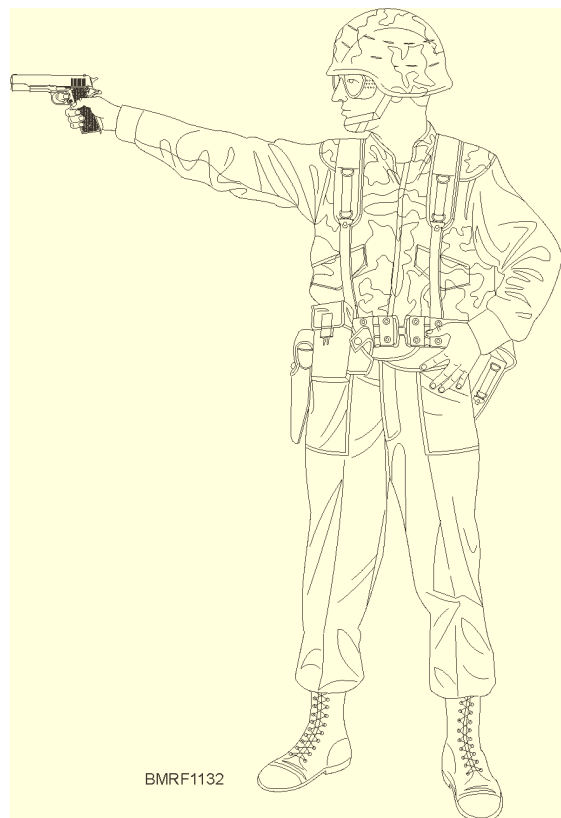

Figure 11-32.—Standing position (pistol).

Student Notes:

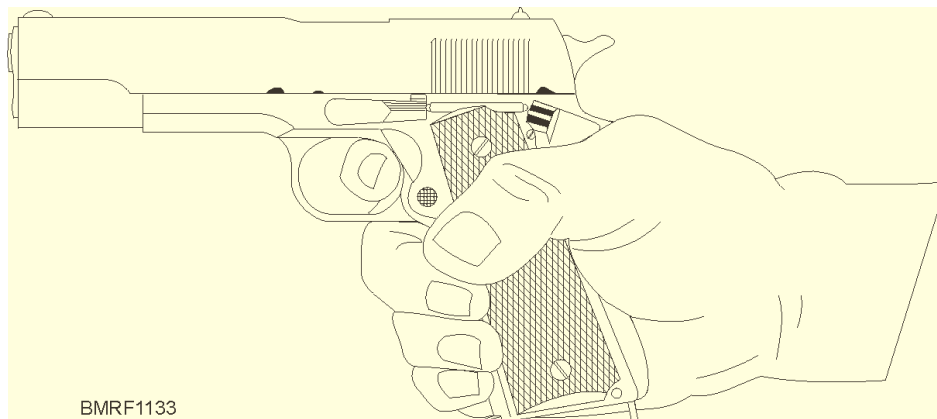

Figure 11-33.—Gripping the pistol (one hand).

As you read this paragraph, refer to figure 11-33. Grip the receiver firmly with the hand and fingers. Wrap the three lower fingers around the receiver (grip), and place the trigger finger on the trigger between the tip and second joint so that the trigger can be squeezed to the rear. Hold your thumb up and along the side of the pistol with enough pressure to steady the pistol and to equalize any pressure from the other side by the palm and forefinger. Once you have a firm grip, maintaining the same degree of firmness throughout firing is important. A change in your grip will change the location of the shot group on the target. A tight grip tends to cause the bullet to strike low and a loose grip to strike high.

With a proper grip on the pistol, the muscles of your arm should be firm, but not rigid. Your arm should be straight with your wrist and elbow locked. This will prevent excessive up-and-down movement of the weapon. When the weapon is fired, the recoil will be absorbed through the arm to the shoulder. If you are in the correct position, the pistol will return to approximately the same sight picture after each shot.

STANDING POSITION TWO-HAND GRIP.—

In this position (fig. 11-34), you face the target squarely with your feet placed comfortably about shoulder width apart. Keep your legs straight without stiffness and your hips level and slightly forward. Relax the muscles of your diaphragm, and make no effort to hold in your abdomen.

Grasp the pistol in the same manner as if you were firing one-handed. Place the nonfiring hand under the firing hand, wrapping the nonfiring fingers around the



Figure 11-34.—Standing position (pistol), two-handed grip.

back of the firing hand. Place the thumb over the middle finger of the firing hand. Lock the weapon firmly in both hands (fig. 11-35). Bring the weapon onto the center of the target by shifting your feet.

MISCELLANEOUS.—In both the one-hand and two-hand positions, position your head so that you are

Student Notes:

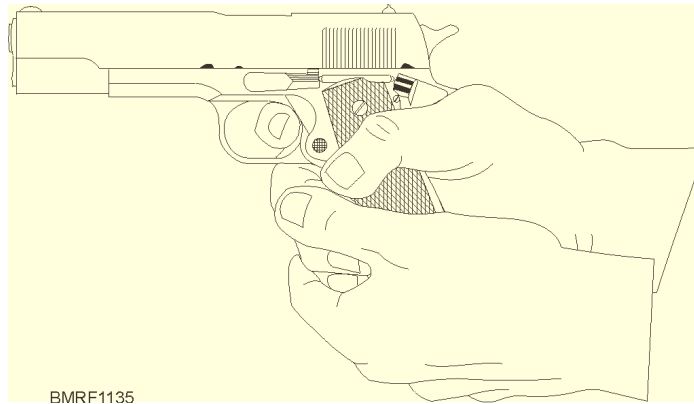

Figure 11-35.—Two-hand grip.

looking straight out through your shooting eye. Keep your shooting arm fully extended.

In the one-handed position, the shoulder of your shooting hand should be slightly raised. Turn your head in order to see the target through the sights. The ease with which your head can be turned is another determining factor in how far you must turn to the right or left. There should be no strain on the neck muscles with your head held upright. The whole position, with the exception of your shooting arm, is one that can be maintained with the least muscular effort. Your body is balanced, rather than held in position. The muscles of your shooting arm and shoulder should be tightened somewhat to sustain the weight of the pistol and to maintain a correct grip. Excessive tightening of the muscles of your shooting arm and hand should be avoided. The tension in the muscles of your shooting arm and hand should be maintained after the hammer falls. This will assist in getting off your second shot quicker.

Because of the differences in the body structure of individuals, the standing position will vary slightly. However, regardless of your size, your position should be relaxed and comfortable. The pistol should point at the center of the target or you will be tense while firing. If you are tense, there will be excessive muzzle movement.

Trigger Squeeze

Poor shooting is most often caused by disturbing your aim as the bullet is leaving the barrel. This is usually the result of jerking the trigger or flinching. The trigger does not have to be jerked violently to spoil your aim; even a slight off-center pressure of your finger while

squeezing the trigger is enough to move the strike of the bullet several inches.

- Flinching is a subconscious reflex caused by anticipating the recoil from firing.
- Jerking results from attempting to fire the pistol at the precise time that you align the sights with the target.
- Heeling causes the bullet to strike the target high and to the right.

You can correct all these shooting errors by understanding and using the correct trigger squeeze. Both flinching and jerking will cause the bullet to strike the lower left section of the target. An attempt to correct flinching and jerking by tightening the large muscle in the heel of the hand may cause heeling. An improper trigger squeeze will cause more misses on the target than any other single step of preparatory marksmanship training.

You obtain a correct trigger squeeze by applying a uniformly increasing pressure on the trigger straight to the rear without disturbing the sight alignment until the pistol fires. The trigger slack, or free play, is taken up first, and the correct squeeze continues steadily until the hammer falls. If the trigger is squeezed properly, you will not know when the hammer will fall. This is the best way to prevent jerking, flinching, and heeling.

To help you squeeze the pistol trigger properly, use the acronym BRASS as you did with the rifle. You must also learn to call your shots. If you cannot call your shots

Student Notes:

correctly, you are not concentrating properly on sight alignment and trigger squeeze.

REVIEW 5 QUESTIONS

- Q1. When you have properly aligned your sights, what is the relationship between the front sight and the rear sight?
- Q2. The distance between your eye and the rear sight is referred to as the _____.
- Q3. Why is it sometimes necessary to blacken sights during sighting and aiming exercises?
- Q4. List the three standard positions for shooting.
- a.
 - b.
 - c.
- Q5. List the three sitting positions for shooting.
- a.
 - b.
 - c.
- Q6. What is the single most important factor in good marksmanship?

Q7. What does the acronym BRASS mean?

Q8. When sighting with a pistol, how should the top of the front sight align with the rear sight?

SUMMARY

In this chapter, you have learned about various small arms used by the Navy. You may never have the occasion to use small arms; then again you may use them every day in your routine aboard a ship. It is imperative that when using small arms, you ALWAYS abide by all prescribed safety precautions. The use of safety equipment is also essential. Respect small arms, but don't be afraid of them. They can be your best source of personal defense in times of trouble if handled properly. All the small arms used by the U.S. Navy are manufactured to have a high degree of reliability if they are cared for and maintained properly. Proper maintenance could mean the difference between your small arm working properly or jamming at critical moments.

Take advantage of every opportunity you may have of going to a rifle or pistol range. The more familiar you become with small arms, the better you will be able to handle them safely. The more you shoot, the better you will become.

REVIEW 1 ANSWERS

- A1. When handling a firearm, you should never **carry the weapon by the muzzle.**
- A2. The protective gear you should wear when firing a weapon includes—
- a. **hearing protection and**
 - b. **safety goggles.**

Student Notes:

REVIEW 2 ANSWERS

- A1. The M-14 rifle is chambered to fire the **7.62-mm NATO cartridge**.
- A2. Fully loaded, the M-14 weighs **11 pounds**.
- A3. Identify the following rifle components as either M16A1 or M16A2:

Component	Rifle
a. Has a lighter barrel because of the ammunition fired	M16A1
b. Rear sights are adjusted by means of a windage knob and elevation knob	M16A2
c. Has a semiautomatic or burst feature	M16A2
d. Fires a 5.56-mm round and a 62-grain round	M16A1 M16A2

- A4. The first step in cleaning the M16 rifle is to **point the selector lever toward SAFE**.
- A5. The M16 rifle carries **20 or 30 rounds** of ammunition.
- A6. When loading the M16 rifle, you shouldn't ride the charging handle forward because the **bolt may fail to lock**.
- A7. When the selector is set for burst, the M16A2 fires **three rounds**.
- A8. The conditions that must exist to consider the M16 rifle clear include—
 - a. **No case or rounds is/are in the chamber**
 - b. **The magazine is out**
 - c. **The bolt carrier is to the rear**
 - d. **The selector lever is on the SAFE position**
- A9. The cleaning materials for the M16 are stored **in the rifle stock**.

REVIEW 3 ANSWERS

- A1. A .45-caliber pistol magazine will hold **seven cartridges**.
- A2. The .45-caliber pistol was designed to be used as **an individual weapon for close use**.
- A3. The three safety features of the 9mm service pistol are—
 - a. **Ambidextrous safety**
 - b. **Firing pin block**
 - c. **Half cock notch**
- A4. When loading your pistol, you should make sure the safety is in the **down position**.

REVIEW 4 ANSWER

- A1. The shotgun has the advantage of being able to **expel anywhere from nine to hundreds of projectiles covering a wide area**.

REVIEW 5 ANSWERS

- A1. When you have properly aligned your sights, **the top of the front sight is level with the horizontal center line of the rear sight, and the body of the front sight is centered between the rear sight aperture**.
- A2. The distance between your eye and the rear sight is referred to as **eye relief**.
- A3. At times, it's necessary to blacken sights during sighting and aiming exercises **to reduce reflection and glare**.
- A4. The three standard positions for shooting are—
 - a. **Standing**
 - b. **Kneeling**
 - c. **Sitting**

A5. The three sitting positions for shooting are—

- a. **Open leg**
- b. **Cross leg**
- c. **Cross ankle**

A6. The single most important factor in good marksmanship is **trigger control**.

A7. The acronym BRASS means **breath, relax, aim, slack, squeeze**.

A8. When sighting with a pistol, **the front sight is level with the top of the rear sight**.

ASSIGNMENT 7

Textbook Assignment: Chapter 11 “*Small Arms.*”

1. Every firearm used by Navy personnel has some type of safety device built in.
 1. True
 2. False
2. Which of the following is the prime cause of accidental shootings?
 1. Faulty gun
 2. Faulty ammunition
 3. Alcohol or drug use by the user
 4. Negligence or carelessness of the user
3. Which of the following are acceptable ear protective devices?
 1. Insert type
 2. Circumaural type
 3. Both 1 and 2 above
 4. Cotton type
4. The M14 rifle is best described by which of the following groups of characteristics?
 1. Medium weight, recoil-operated, magazine-fed, and fully automatic
 2. Medium weight, gas-operated, clip-fed, and capable of semiautomatic and fully automatic fire
 3. Lightweight, recoil-operated, clip-fed, and semiautomatic
 4. Lightweight, gas-operated, magazine-fed, and capable of semiautomatic or automatic fire
5. Which of the following types of ammunition is used with the M14 rifle?
 1. 7.62-mm NATO cartridge
 2. 20-round magazine
 3. M76 grenade launcher
 4. Each of the above
6. What is the maximum range of the M14 rifle?
 1. 2,500 yards
 2. 3,250 yards
 3. 4,075 yards
 4. 5,250 yards
7. The M16A1 and M16A2 rifles are best described by which of the following groups of characteristics?
 1. Clip-fed, recoil-operated weapons
 2. Magazine-fed, recoil-operated shoulder weapons
 3. Magazine-fed, gas-operated shoulder weapons
 4. Clip-fed, gas-operated weapons
8. For what size cartridge is the M16A1 rifle chambered?
 1. .38 caliber
 2. .45 caliber
 3. 5.56 mm
 4. 7.62 mm
9. What is the maximum magazine capacity of the M16A1 rifle?
 1. 15 rounds
 2. 25 rounds
 3. 30 rounds
 4. 35 rounds
10. What is the muzzle velocity of the M16A1 and M16A2 rifles?
 1. 2,500 feet per second
 2. 3,000 feet per second
 3. 3,500 feet per second
 4. 4,000 feet per second
11. What means is used to adjust the rear sights of the M16A2 rifle?
 1. A windage drum
 2. A windage knob and an elevation knob
 3. A clip lever marked range
 4. A slide adjust to windage
12. What is the first step to take when handling any weapon?
 1. Point the selector lever toward SAFE
 2. Remove the magazine
 3. Visual check of the chamber
 4. Lock the bolt open

13. Why should the selector be on SAFE during assembly and disassembly?
 1. To prevent damage to the automatic sear
 2. To prevent damage to the firing pin
 3. To prevent the barrel from releasing
 4. To prevent the rear slide from disengaging
14. When the selection lever is in the burst position, the M16A1 rifle fires in what way?
 1. In short bursts of two rounds
 2. In short bursts of three rounds
 3. Four rounds each time the trigger is pulled
 4. Six rounds each time the trigger is pulled
15. The M16A1 rifle is clear when which of the following conditions are met?
 1. No case or round is in the chamber and the magazine is out
 2. The bolt carrier is to the rear
 3. The selector lever is on the SAFE position
 4. All of the above
16. When cleaning the barrel bore and chamber of the M16A1 rifle, you should not reverse the brush while in the bore for what reason?
 1. The barrel slide will be damaged
 2. The bore may jam
 3. The trigger pin will need to be replaced
 4. The bore cleaner will not work
17. What parts of the barrel bore and chamber should you lubricate after you've finished cleaning them?
 1. The locking lugs
 2. The extractor ejector
 3. The lugs in the barrel extension
 4. The magazine springs
18. When cleaning ammunition magazines, you need to make sure the magazine is dry for what reason?
 1. The magazine and ammunition can corrode and become dangerous to use
 2. The spring action will tighten up
 3. The ammunition will jam
 4. The magazine won't load
19. The .38-caliber revolver is best described by which of the following groups of characteristics?
 1. Cylinder-loading, single- or double-action, manually operated hand gun
 2. Semiautomatic, recoil-operated, magazine-fed hand gun
 3. Semiautomatic, cylinder-loading double-action hand gun
 4. Cylinder-loading, recoil-operated, manually operated hand gun
20. The .45-caliber service pistol is best described by which of the following groups of characteristics?
 1. Cylinder-loading, single- or double-action, manually operated hand gun
 2. Semiautomatic, recoil-operated, magazine-fed hand gun
 3. Semiautomatic, cylinder-loading double-action hand gun
 4. Cylinder-loading, recoil-operated, manually operated hand gun
21. The .45-caliber revolver has what maximum range and maximum effective range, respectively?
 1. 1,800 yards, 75 yards
 2. 1,500 yards, 50 yards
 3. 1,450 yards, 45 yards
 4. 1,250 yards, 30 yards
22. The magazine capacity of the 9mm service pistol can hold how many rounds in the magazine?
 1. 5 rounds
 2. 10 rounds
 3. 15 rounds
 4. 20 rounds
23. The 9mm service pistol is best described by which of the following groups of characteristics?
 1. Semiautomatic, recoil-operated, magazine-fed hand gun
 2. Semiautomatic, magazine-fed, recoil-operated, double-action pistol
 3. Semiautomatic, cylinder-loading double-action hand gun
 4. Semiautomatic, magazine-fed, single-action pistol

24. Which of the following are safety features incorporated in the 9mm service pistol?
 1. Ambidextrous safety
 2. Firing pin block
 3. Half cock notch
 4. All of the above
25. What safety feature of the 9mm pistol prevents accidental discharge?
 1. Firing pin block
 2. Half cock notch
 3. Muzzle pressure
 4. Rear trigger guard
26. The advantage of shotguns over pistols is that sight alignment is not as critical.
 1. True
 2. False
27. What maximum number of rounds of 12-gauge, 2 3/4-inch ammunition will the magazine of the M870 shotgun hold?
 1. One
 2. Two
 3. Three
 4. Four
30. What is meant by the terms “spot weld” or “anchor”?
 1. The distance of your eye from the peep sight in any particular firing position
 2. Holding your rifle in the exact same position to make sure your eye stays the same distance from the peep hole
 3. The distance of your eye from the peep sight, depending on your firing position
31. What is the focus for the eye?
 1. The front sight
 2. The rear sight
 3. The aiming point
 4. The sight picture
32. What is the correct aiming point on a type “A” target?
 1. 3 o’clock
 2. 6 o’clock
 3. 9 o’clock
33. What elements do you need to align to get a correct sight picture?
 1. The rear sight only
 2. The front sight only
 3. The bull’s eye only
 4. The rear sight, front sight, and bull’s eye

QUESTIONS 28 THROUGH 33 REFER TO RIFLE FIRING TECHNIQUES.

28. When firing a rifle, what factors make up the sight picture?
 1. Rear sight
 2. Correct aiming point only
 3. Sight alignment only
 4. Correct aiming point and sight alignment
29. What is meant by the term “eye relief”?
 1. The different distance from the rear sight of your aiming eye, depending on your firing position
 2. The distance of your eye from the peep sight in any particular firing position
 3. The height of the rear sight
 4. The height of the front sight
34. How many standard firing positions are taught in the Navy?
 1. Two
 2. Three
 3. Four
 4. Five
35. Which of the following firing positions is most useful when you are constantly firing and moving?
 1. Sitting
 2. Standing
 3. Kneeling
36. Which of the following firing positions is most useful when you are on level ground or firing uphill?
 1. Sitting
 2. Standing
 3. Kneeling

37. Which of the following firing positions is most useful when you are firing downhill?

1. Sitting
2. Standing
3. Kneeling

38. What is the key to trigger control?

1. Squeeze the trigger smoothly, gradually, and evenly straight to the rear
2. Placing the finger at the very tip of the trigger
3. Constant pressure on the trigger
4. Squeeze the trigger quickly and evenly straight to the rear

39. Remembering which of the following acronyms will help you remember correct shooting techniques?

1. AIM
2. RELAX
3. BRASS
4. SLACK

40. You should take a breath, let out a little air, and then hold your breath until you fire your rifle. However, if you haven't fired within 10 seconds, what should you do?

1. Breath normally and continue squeezing the trigger
2. Take another breath and start the aiming procedure over
3. Let out more air and firmly jerk the trigger
4. Continue holding your breath and start the aiming procedure over

QUESTIONS 41 THROUGH 43 REFER TO FIRING TECHNIQUES FOR THE 9mm SERVICE PISTOL.

41. What is a correct sight picture?

1. Correct sight alignment and correct aiming point
2. Off center to the target
3. Bottom of the picture
4. Top of the picture

42. The pistol can be accurately fired from how many positions?

1. Two
2. Three
3. Four
4. Five

43. Missing the target is most often caused by

1. sight misalignment
2. bent barrel
3. improper trigger squeeze
4. bad ammunition