

## CHAPTER 12

# DAMAGE CONTROL

*...the events of 14-15 April 1988 have proven that solid damage control, good training, and sound leadership based on experience can save a ship that is on fire and sinking, to fight another day.*

—Paul X. Rinn, CAPT  
CO, USS *Samuel B. Roberts* (FFG-58)

Damage control is the responsibility of ALL HANDS, from the commanding officer to the newest recruit. Without proper damage control training, your shipmates may be injured or killed, or perhaps your ship may sink. During World War II, many ships were saved because of the positive damage control practices.

For instance, the German battleship *Bismarck* was kept afloat and remained in a fighting status for an extended period in spite of the British pounding it with heavy gunfire. You can see that survivability through positive damage control is not only important for the United States, but on an international level.

Effective damage control (DC) requires the correct use of equipment and techniques to prevent or minimize the damage effects caused by battle, fire, collision, grounding, explosion, and so forth. DC also includes defensive measures used to reduce the effects of weapons of mass destruction, such as chemical, biological, and radiological (CBR) warfare. Remember, our Navy gives you the best damage control training in the world. As a ship's crew member, it's your responsibility to properly safeguard yourself and your ship. You learn how to do this through training.

You may feel the information in this chapter doesn't apply to you because of your chosen occupational field. Remember that as a Sailor, no matter what your rating, you may serve aboard ship at any point in your career. Therefore, as a crew member, you must know your damage control responsibility. For more in-depth information about the administration and organization of damage control, you should refer to the following manuals:

- *Surface Ship Survivability*, Naval Warfare Publication (NWP) 3-20.31
- *Naval Ship's Technical Manual (NSTM)*, chapter 079, vol. 2, "Practical Damage Control"

- *Naval Ship's Technical Manual (NSTM)*, chapter 555, vol. 1, "Surface Ship Firefighter"

Our Navy has a complete organization in place relating to damage control. This organization consists of the following two main parts:

1. The administrative organization, and
2. The battle organization.

### ADMINISTRATIVE ORGANIZATION

Learning Objectives: When you finish this chapter, you will be able to—

- Identify the chain of command within the damage control administrative organization.
- Recognize the functional purpose of each part of the organization and the interrelationships between the parts.

The damage control administrative organizational chain of command is shown in figure 12-1. As you can see, the responsibility for damage control begins with the commanding officer (CO) of a naval ship and runs to the most junior Sailor in the DC division and damage control petty officer community.

Look at figure 12-1. As you can see at the level of the ship's damage control assistant (DCA), other personnel report to the DCA. Each person has a different administrative responsibility and tasking. Each person reports back up the chain via the DCA.

### PURPOSE OF ADMINISTRATIVE ORGANIZATION

The administrative organization requires the efforts of all hands to establish and maintain material readiness conditions. Material readiness is

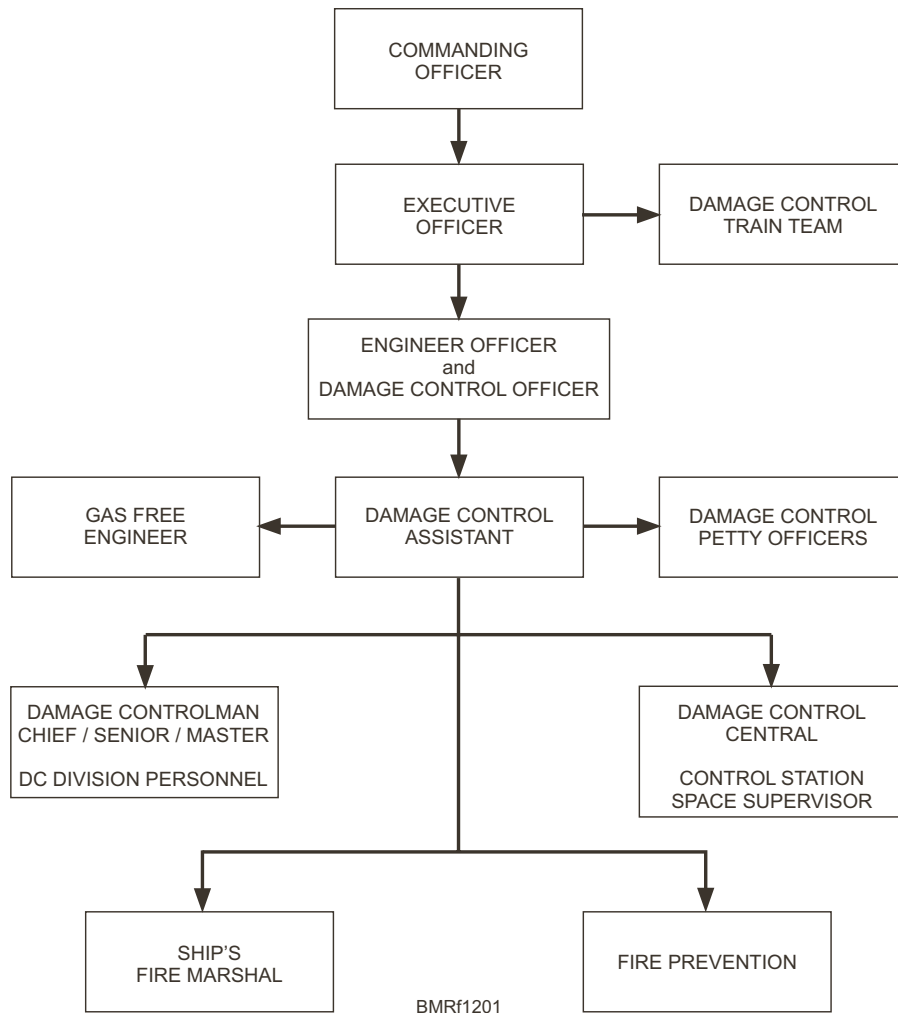

**Figure 12-1.—Administration organization chain of command.**

accomplished when DC fittings and equipment aboard ship are available and in proper working order to combat any emergency. Aboard ship, there is a damage control petty officer (DCPO) for each department or division. The DCPO makes sure that all emergency equipment and fittings are maintained and work properly. The DCPO also maintains the compartment checkoff list.

Each ship has a specified number of damage control lockers with a repair party assigned. Repair parties and repair locker personnel, along with the DCPOs, receive periodic training so they can perform their assigned duties. The engineer officer is responsible for maintaining properly trained DCPOs, repair parties, and repair locker personnel. Under the engineer officer, the DCA coordinates the efforts of the repair parties to

control damage. Also, the DCA oversees all DC training. When properly maintained, the administrative organization reduces and confines any initial damage.

The survivability of a ship depends on the level of preparedness of its personnel. The condition of the equipment, shipboard systems, and the amount of training are factors that affect the ship's survivability. Ship's bills, records and schedules for maintenance, written doctrine, and procedures relating to damage control are all part of the administrative organization of damage control.

For the list of responsibilities for various ship's personnel, refer to OPNAVINST 3120.32, or ask your LPO or LCPO.

---

***Student Notes:***

## COMMANDING OFFICER

*United States Navy Regulations* states the various broad responsibilities of the commanding officer (CO). These regulations require the commanding officer to maintain his/her command in a state of maximum effectiveness for war. They also require that he/she repair as much damage as possible immediately after a battle or action.

To carry out this charge, the CO must ensure that the ship's officers and crew are trained and continually exercised in all aspects of survivability. The CO should be fully aware of the adequacy and operability of all survivability systems and equipment. Shortages and deficiencies must not be tolerated, and they should be immediately rectified (fixed) or reported as casualties in the ready reporting system.

## EXECUTIVE OFFICER

The executive officer (XO) keeps the command informed of the ship's survivability readiness. The XO carries out the requirements regarding the ship's survivability training, the readiness to manage casualties, and the readiness to control and recover from damage. As the team leader, the XO is the senior person assigned to the damage control training team (DCTT). The DCTT is responsible for all shipboard drills and exercises in the area of damage control.

## DAMAGE CONTROL TRAINING TEAM

Each ship has a DCTT. The DCTT trains the ship's DC organization in ship equipment, ship systems, and procedures and techniques relating to the ship's survivability. The DCTT is organized to train all types of DC-related exercises.

The DCTT evaluates and critiques the DC team's abilities as well as their own. The team is made up of a variety of ratings, which provides the ship with a wide range of experience. All team members are qualified, as a minimum, to at least the level of personnel they are training and/or evaluating.

## ENGINEER OFFICER

The engineer officer is designated as the ship's damage control officer. The ship's engineer officer fills the billet as the department head of the engineering department, and the DC division is one of the divisions in that department. The engineer officer has the following responsibilities:

- The operation, care, and maintenance of the main propulsion plant, auxiliary machinery, and piping systems
- The control of damage
- The operation and maintenance of electric power and distribution systems
- Repairs to the hull
- Repairs to material and equipment in other departments that require the attention of engineering department

Also the damage control officer (DCO), the engineer officer reviews all administrative items drafted by the DCA and DCA personnel. This is a primary administrative duty that occurs before items are routed to the CO for approval.

## DAMAGE CONTROL ASSISTANT (DCA)

The DCA is the primary assistant to the damage control officer in the areas of damage control; firefighting; and chemical, biological, and radiological defense. For the purpose of administrative organization, the DCA is in charge of many programs relating to damage control on the ship and monitors the effectiveness of other programs.

The DCA is responsible for the overall administration and training of the ship's DC organization. Under the guidance of the DCA, individual departments and divisions are responsible for administration and training as related to damage control for their personnel. All ships afloat must meet the minimum prescribed formal training requirements to include training for the following personnel:

---

### *Student Notes:*

- All DCTT members
- In-port emergency teams (IETs)
- Rescue and assistance (R&A) detail
- Repair party personnel
- Damage control petty officer (DCPO) organization
- All hands

Shipboard training by the DCTT is scheduled, executed, and documented to meet the type commander's (TYCOM's) requirements. The DCA maintains records of all DC personnel qualification standards (PQS) accomplishment for all hands.

All ship's instructions relating to casualty prevention and response are either drafted by or drafted for and reviewed by the DCA. This review is made before seeking the approval and signature of the ship's CO. The DCA is the resident expert for the engineer officer and the command on instructions relating to casualty prevention and response. The DCA administers the following billets and programs: DCPO, gas free engineer (GFE), fire marshal and fire prevention, and the operation of damage control central (DCC) and supporting watches.

## **DAMAGE CONTROL DIVISION**

The damage control division is responsible for the damage control systems and equipment on board ship. The DCA is the senior member (division officer) of the DC division. As such, the DCA oversees all the paper work and the scheduling for maintenance of these systems and equipment.

### **Damage Control Petty Officer (DCPO)**

A petty officer, who has completed the PQS, is designated as the damage control petty officer (DCPO) based on TYCOM instructions. Each work center has a DCPO. Division officers nominate DCPOs for endorsement by the chain of command. The XO gives the final approval for the nomination, replacement, and

rotation of all DCPOs. DCPOs normally serve for a period of 6 months; they check with the fire marshal and DCA when first assigned to or relieved from this duty.

The DCPO is responsible for—

- Acquainting themselves with all phases of the ship's damage control, firefighting, and defense procedures
- Assisting with the instruction of division personnel in damage control
- Firefighting, egress, and CBR procedures
- Ensuring the preparation and maintenance of damage control checkoff lists for all spaces under their cognizance
- Supervising the setting of specified damage control material conditions within division spaces and making all required reports
- Weighing portable CO<sub>2</sub> bottles, inspecting and testing damage control and firefighting equipment, and preparing all required reports for approval of the division officer based on current ship's instructions and planned maintenance system (PMS) requirements
- Ensuring all battle lanterns, dog wrenches, spanners, and other damage control equipment are in place and in a usable condition in all division spaces
- Ensuring all compartments, piping, cables, and damage control equipment are properly stenciled or identified by color codes based on *NSTM*, chapter 079, volume 2, and *General Specifications for Ships of the United States Navy*, NAVSEA S9QQO-AA-SPN-010/Gen-Spec, chapters 505, 507, and 602
- Ensuring the posting of safety precautions and operating instructions in required division spaces
- Assisting the division officer in inspection of division spaces for cleanliness and preservation and assisting in the preparation of required reports

---

## ***Student Notes:***

- Conducting daily inspections of division spaces for the elimination of fire hazards
- Performing any other actions in regard to damage control and maintenance of spaces that are directed by the division leading petty officer, division officer, fire marshall, DCA, and executive officer

### **Gas Free Engineer (GFE)**

The gas free engineer (chief petty officer or above) decides when it's safe for personnel to enter closed or poorly ventilated spaces. The GFE makes sure that all necessary measures have been taken to eliminate the risk of fire, explosion, exposure to toxic substances, suffocation, or asphyxiation. The GFE has a working knowledge of all definitions, instruments, and equipment listed in the GFE program. The shipboard GFE meets the qualifications and is capable of performing the duties and responsibilities specified in *NSTM*, chapter 074, volume 3, "Gas Free Engineering." All Navy ships must be adequately staffed with personnel qualified to perform gas free engineering services for normal and emergency situations.

### **Fire Marshal**

All ships designate a fire marshal to assist the engineer officer. The fire marshal helps the DCA train personnel to prevent and fight fires. The ship's fire marshal and duty fire marshals are qualified to ensure continuity of inspections for improperly stored or inoperative DC equipment. Fire marshals are free of duties that would not let them instantly respond to emergencies. The fire marshal conducts daily inspections throughout the ship, paying particular attention to the following areas:

- Housekeeping
- Firefighting equipment, both portable and fixed
- Safety precautions
- Flammable liquids
- Smoking

- Welding and burning
- Stowage of compressed gas
- Fume/spraytight light covers
- Grease filters/traps, Gaylord hoods
- Ventilation/air conditioning ducts/flammable stowage ventilation
- Material condition

The fire marshal has the following responsibilities:

- Submitting reports citing fire hazards and making recommendations for correction

### **NOTE**

Immediate steps should be taken to eliminate hazards resulting from poor housekeeping, welding or burning, smoking, and equipment deficiencies. The fire marshal submits discrepancy reports to the DCA with copies to the XO and the appropriate department head(s) and conducts follow-up inspections to ensure compliance.

- Conducting training for fire teams, rescue and assistance teams, and departmental/divisional DCPOs stressing fire hazard consciousness
- Setting up a fire watch team before regular/interim overhauls or availabilities
- Training and assigning fire watches
- Being overall in charge at the fire scene until relieved by a general quarters (GQ) scene leader and keeping DCC and/or the OOD informed with an accurate status of the situation

---

### ***Student Notes:***

## REVIEW 1 QUESTIONS

- Q1. The damage control organization is divided into what two main parts?
- a.
  - b.
- Q2. What is the purpose of the administrative phase of DC?
- Q3. Who is responsible to maintain properly trained DCPOs, repair parties, and repair locker personnel?
- Q4. Who is the senior person assigned as team leader on DCTT?
- Q5. What person is responsible for making sure that all battle lanterns, dog wrenches, spanners, and other damage control equipment are in place and in a usable condition within their division?
- Q6. Before anyone can enter a poorly ventilated space or void, who must certify the space as safe?

## BATTLE ORGANIZATION

**Learning Objectives:** When you finish this chapter, you will be able to—

- Recognize the battle organization of damage control parties.

- Recall the location and contents of shipboard damage control lockers.

The battle phase starts when the ship has received actual damage. The DCA coordinates the efforts of the repair parties from damage control central (DCC). These efforts may include fighting fires, flooding, controlling the ship's stability, and repairing battle damage. Repair party personnel also use CBR defense measures (CBR is covered in chapter 13).

## PURPOSE OF THE BATTLE ORGANIZATION

Once the ship has been damaged, the ship's damage control battle organization is responsible for restoring the ship to as near normal operation as possible. The organization varies somewhat from one ship to another, depending on the size, type, and mission of the ship. However, the same basic principles apply to all battle organizations.

The DCA is responsible, under the engineer officer, for the ship's survivability systems. The DCA's responsibilities include control of damage; control of stability, list, and trim; fighting fires; restoration from damage; medical casualty response; and CBR countermeasures. The battle station for the DCA is DCC. The primary damage control battle organization units are repair parties or teams. Battle dressing stations (satellite medical stations) should be located near the repair parties.

## DAMAGE CONTROL CENTRAL/CENTRAL CONTROL STATION

The primary purpose of damage control central (DCC) is to collect and compare reports from various repair stations to determine the ship's condition and the corrective action to be taken. DCC is the nerve center and directing force of the entire damage control organization. Personnel from various shipboard divisions man DCC. On newer class ships, the central point for reporting is the central control station (CCS). The CCS has the added capability of being able to control the closing of fire zone (FZ) doors and certain valves electronically. Also, CCS can remotely activate fire-fighting systems.

---

**Student Notes:**

Reports from the repair parties are carefully checked in DCC/CCS. This is done so that immediate action can be taken to isolate damaged systems and to make effective emergency repairs. As reports are received, graphic records of the damage are made on damage control diagrams and status boards under the direction of the DCA. For example, reports on flooding are used to update the status boards showing the liquid distribution (fuel and water) before the damage occurred. With this information, the stability and buoyancy of the ship can be estimated and necessary corrective measures taken.

In the unlikely event DCC/CCS is destroyed or is unable to retain control, a plan is in place to designate repair stations to take over the responsibilities of damage control central.

### REPAIR PARTIES

The following chart shows a variety of repair lockers that are found on an aircraft carrier. All ships have a minimum of repair lockers 2, 3, and 5. Each locker has an officer or senior petty officer in charge. The makeup of each repair party in these lockers depends on the type of ship and the area they serve.

Repair Locker	Location or Function
Repair 1	Main deck repair
Repair 2	Forward repair
Repair 3	After repair
Repair 4	Amidships repair
Repair 5	Propulsion repair
Repair 6	Ordnance
Repair 7	Gallery deck and island structure
Repair 8	Electronic casualty control

### Repair Party Personnel

For a repair party to control battle damage effectively, PQS-qualified personnel are assigned to specific functions and duties. Some personnel may have

more than one assignment, depending on the number and qualifications of personnel available. Repair party personnel must know their own area of responsibility along with the areas of other repair parties. The following functions are common to all repair parties:

- Make repairs to electrical and communication circuits and rig casualty power.
- Give first aid and transport injured personnel to battle dressing stations without seriously reducing the party's damage control capabilities.
- Detect, identify, and measure radiation dose and dose rate intensities.
- Decontaminate the affected areas of nuclear, biological, and chemical attacks.
- Identify, control, and extinguish all types of fires.
- Control and remove flooding water.
- Evaluate and correctly report the extent of damage in the repair parties' area of responsibility, to include maintaining—
  - Deck plans showing location of CBR contamination, location of battle dressing stations, casualty collection and decontamination stations, and safe routes to them.
  - Graphic display boards showing damage and action taken to correct disrupted or damaged systems, using standard DC symbology and plotting techniques.
- Make emergency repairs to various piping systems.
- Be familiar with all damage control fittings in the assigned area, such as watertight doors, hatches, scuttles, ventilation systems, and various valves.
- Control and clean up hazardous material spills.

---

### *Student Notes:*

## **In-Port Emergency Team (IET)**

In-port emergency teams are made up of duty section personnel. IET members are emergency team member qualified and stand ready to respond to any type of casualty.

At times, it may be necessary to provide additional personnel and material support to the IET. These additional personnel come from a pool of excess duty personnel and assemble at a designated location. They can assist in setting fire or flooding boundaries and are available to back up the primary IET, if needed.

## **Rescue and Assistance (In Port/At Sea)**

All ships are required to have a rescue and assistance detail in port and at sea. The primary missions of this detail are to rescue personnel at sea, assist another unit in distress, and assist persons or activities in distress ashore. All personnel assigned to the rescue and assistance detail must, as a minimum, be qualified as an emergency team member and in first aid.

## **Rapid Response Team**

When in port or under way, each ship has a designated rapid response team. This team proceeds directly to the scene when a fire or flooding is called away. The team attempts to quickly extinguish or contain the fire or minimize or stop a flooding. At a minimum, this team is made up of four personnel qualified as fire team members and the ship's fire marshal. Because immediate response is required, protective clothing or OBAs aren't donned. If they are unable to gain control of the casualty within a preset time frame, a full IET or GQ team relieves them and takes over.

## **General Quarters (GQ)**

General quarters is an all hands evolution. It is the highest state of readiness of the ship, and all repair lockers are manned and fully equipped to combat casualties. When responding to GQ, all hands adjust their clothing to battle dress and proceed to their GQ stations.

Battle dress—Bottom of pants tucked into boots or socks, long sleeves pulled down and buttoned, top button on shirt buttoned, and flash hood and gloves donned. All exposed skin covered.

GQ route—Move forward in passageways and up ladders on starboard side, move aft in passageways and down ladders on port side. Since all hands will be moving at the same time, you have to move with the flow of traffic.

## **DAMAGE CONTROL LOCKERS**

The equipment and materials required for making battle damage repairs vary according to the nature of the damage. Since many different kinds of damage can occur aboard ship, you must know how to use a variety of equipment and materials.

Checks should be made to see that all damage control equipment tools and materials on the allowance list are actually on board and in working order. Comparing the ship's allowance list with an accurate and up-to-date inventory of onboard damage control equipment does that.

Damage control equipment should be stowed or installed in its designated location and be readily accessible. Emergencies can be handled much more effectively if equipment is available than if you have to waste time looking for it.

Damage control equipment must not be used for any purpose other than damage control. Because damage control equipment is located throughout the ship, some people are tempted to use it merely because it is handy. That must not be allowed. It is important to make all hands realize their lives may literally depend on the ready availability of damage control equipment if an emergency should arise.

## **REVIEW 2 QUESTIONS**

- Q1. When does the battle phase of damage control start?

---

## ***Student Notes:***



- Q2. Where is the battle station for the DCA?
- Q3. During GQ, DCC receives reports and casualty status from—
- Q4. What is the minimum requirement to be a member of the in-port emergency team?
- Q5. What are the primary missions of the rescue and assistance team?
- Q6. What is the ship's highest state of readiness?

- Sound-powered telephones
- IVCS
- Ship's service telephones
- Announcing systems
- Intercommunications systems
- DC WIFCOM

## COMMUNICATIONS

**Learning Objectives:** When you finish this chapter, you will be able to—

- Identify the communications devices used during damage control evolutions.
- Recognize the purpose of communications devices used during damage control evolutions.

Communications are vital to the damage control organization. Without good communications, the entire organization could break down and fail in its primary mission. The size and complexity of the surface ships govern the design of DC communications systems found aboard ship. Major shipboard DC communications systems are as follows:

### NOTE

All the systems listed below are explained in detail in chapter 4 of this TRAMAN.

## EMERGENCY COMMUNICATIONS

The X40J is an emergency damage control communication system. It's employed in the event of primary, auxiliary, and supplementary communications circuit failure. The X40J is composed of both portable ("salt and pepper" line) and permanently installed (risers) components.

## ALARMS

The general announcing system (1MC) is integrated with a system of alarm signals. The signals override the microphone control stations and are intended to notify the ship's crew of imminent danger. These alarms, in order of priority, are as follows:

1. Collision
2. Chemical attack
3. General
4. Flight crash

### Collision Alarm

The OOD/conning station sounds this alarm signal when there is a possibility that the ship will run into a pier, run aground, or another waterborne unit will strike the ship. All hands should move away from the area of impact and brace for shock. After a collision, all hands set material condition ZEBRA and are prepared to control fires and flooding.

### Chemical Attack Alarm

The chemical attack alarm signal is sounded by the OOD/conning station, DCC, and automatically by the chemical agent point detection system (CAPDS) on

---

### *Student Notes:*

ships so equipped. This alarm is sounded when there has been a CBR attack on or in the vicinity of the ship. All hands must exercise protective measures and procedures to reduce exposure and personnel injuries.

### General Alarm

The general alarm signal is sounded by the OOD to notify the crew of a battle condition (GQ). Immediately after the alarm is sounded, some ships pass the word, “General quarters, general quarters, all hands man their battle stations.” All hands report to preassigned stations following the correct GQ traffic routes and set material condition ZEBRA.

### Flight Crash Alarm

The flight crash alarm is sounded by the OOD or PreFly to notify ship’s company of a pending or actual flight deck emergency.

### MESSENGERS

Messengers are used to deliver written messages between repair lockers and DCC as a matter of record. If all methods of communications have failed, messengers are used to relay orders and information. Messengers deliver messages between repair lockers and DCC, between DCC and the bridge, or between other locations. Messengers should be familiar with the ship to get from one place to the other without delay. Messengers must be able to deliver oral messages without error.

### REVIEW 3 QUESTIONS

- Q1. The X40J circuit is commonly referred to as what kind of line?
- Q2. List the names of the alarms that can override the microphone control of the 1MC.
- a.
  - b.

- c.
- d.

Q3. When all communications systems fail, how are messages and orders relayed between repair lockers and DCC?

## SHIP’S INTEGRITY THROUGH SUBDIVISION

**Learning Objective:** When you finish this chapter, you will be able to—

- Identify material conditions of readiness and recognize their purpose.

Naval ships are subdivided into many small watertight rooms or as we say *watertight compartments*. This breaking up process of a very large area is called the “compartmentation process.” It limits the spread of toxic or noxious gases, fire and flooding, and other battle damage when it occurs. This system when combined with material conditions of readiness (discussed below) increases a ship’s ability to survive.

Each space or compartment on a ship is accessed through a door to a new space or passageway connecting other spaces on the same deck or to the weather deck area (outside). The space may have a hatch or scuttle that allows transit from one deck to another via a ladder. In some spaces you may have many doors, hatches, and scuttles. These accesses are either watertight, airtight, fumetight, oiltight, or nontight by design.

Piping and ventilation systems work on the same concept as compartment access fittings. They have valves at strategic points that will isolate sections of a system, limiting the spread of damage to smaller areas. Because of all the fittings and closures that are on a ship, you might be asking yourself the question, “How will I know which ones to close or leave open and when to do it?” Those answers are covered in the paragraphs to follow.

---

### Student Notes:

## MATERIAL CONDITIONS OF READINESS

There are three material conditions of readiness. Those conditions are named XRAY, YOKE, and ZEBRA. When set, each condition affords the ship with a level of protection, with XRAY being the least and ZEBRA the most. Some fittings or closures on a ship may not be classified although the majority of them are classified. They are identified by a classification plate affixed to the closure or fitting, or sometimes the classification is painted on the bulkhead next to the item. Ship's instructions (and Navy instructions) specify what type of classification an item should hold, how it will be marked, and when that condition should be set. The commanding officer of the ship is authorized by instruction to alter this to a small extent if he/she desires but basically this system is standard Navywide.

**XRAY.** Provides the least watertight integrity and the greatest ease of access throughout the ship. It is set when the threat to the ship is minimal. Condition XRAY is set during working hours when the ship is in port, when there is no danger of attack, and when there is no threat from bad weather. All fittings marked with a black X and circle X are closed when condition XRAY is set.

**YOKE.** Provides a greater degree of watertight integrity than condition XRAY but to a lesser degree than the maximum condition. YOKE is normally set at sea and in port during wartime. All fittings marked with Xs and Ys, Circle X, and Circle Y are closed when condition YOKE is set.

**ZEBRA.** Provides the greatest degree of subdivision and watertight integrity to the ship. It is the maximum state of readiness for the ship's survivability system. Condition ZEBRA is set when the following situations occur:

1. Immediately when GQ is sounded
2. When entering or leaving port in wartime
3. To localize damage and control fire and flooding when the crew is not at GQ
4. At any time the CO deems the maximum condition of survivability should be set

All fittings marked with X or Y, Circle X, Circle Y, Z, Circle Z, and DOG Zs are closed when condition ZEBRA is set.

The setting of material conditions is normally carried out by the division or department responsible for the compartment and is accomplished by using the compartment checkoff lists (CCOLs). In an emergency the repair party personnel responding to the casualty assisted by those Sailors in the area will set the required condition to restrict the spread of damage. CCOLs are a tool used by repair party personnel to find the damage control fittings and closures in each compartment. The fittings and closures are identified by name (type) and a number that represent the location of the fitting by deck, the frame it is located at, and the side of the space similar to the compartment identification process. The CCOL list is posted in each space near the entrance and should be kept up to date by the division who owns the space. An example of a CCOL is shown in (fig. 12-2).

The normal setting of a material condition should be logged in the Damage Control Closure Log by each division or repair party completing the setting. Any exceptions to the setting should also be noted in the log so DCC/OOD are aware of the reduction in the ship's ability to restrict the spread of potential damage. This log and the Inoperative Fitting Log are maintained in either DCC or on the quarterdeck by the OOD. If you have a need to break (open) a fitting that should be normally set in a specific condition, you must first request it open and then log it in before opening the fitting. If you don't do this, you are in violation of the setting and have jeopardized your shipmate's survival. When you have completed work in a space that you needed a fitting/closure open, close it first, then log it closed. Now those who maintain the log will have a clear picture of what is open and closed in a given area of the ship. In addition to the closure log, a log for inoperative fittings and closures exists. As its name implies, this log lists all DC-related fittings and closures on the ship that don't work properly. It becomes a tracking tool for future maintenance.

A modified condition YOKE or modified condition ZEBRA is sometimes set, rather than the normal setting of XRAY, YOKE, or ZEBRA. These are settings of convenience at the discretion of the CO.

---

### *Student Notes:*

COMP'T NO. 2-108-1-L		NAME Crews Berthing (LSD Wing Wall)			
ITEM	FITTING	NUMBER	LOCATION AND PURPOSE	CLASSIFICATION	DIVISION RESPONSIBLE
ACCESS					
1	WT DOOR	2-108-1	Access to: 2-96-1-L	Z	REPIII
2	WT DOOR	2-129-3	Access to: 2-120-1-L	X	REPIII
3	WT HATCH	2-108-1	Access to: 3-108-1-L	X	S
MISCELLANEOUS CLOSURES					
4	ATC	2-108-1	In WITH 2-108-1 used to test: 3-108-1-L 3-103-3-A 3-115-1-A	X	E
5	ATC	2-108-1	In WTD 2-108-1 used to test: 2-95-1-L	X	E
DRAINAGE					
6	DECK SOCKET (remote)	2-112-1	Bilge eductor overboard discharge valve 5-112-1	X	M
7	STC	2-118-1	Sound Ball 6-108-1-W	X	R
8	GAGGED SCUPPER	2-109-1	Plumbing drain from 1-110-1-L	Z	REPIII
FIRE MAIN & SPRINKLING SYSTEM AND WASH DOWN					
9	FMCOV	2-109-1	Cut out to FP 1-109-1	W	REPIII
10	FMCOV	2-110-1	Cut out to Group IV magazine sprinkler	W	REPIII
FUEL OIL					
11	STC	2-116-1	Sound F.O. & Ball. 6-108-3-F	X	B
REMOTE OPERATION					
12	Remote start/stop switch	2-119-1	For exhaust blower 2-108-1	Z	REPIII
MISCELLANEOUS UNCLASSIFIED					
13	Loud speaker		General announcing 1 MC		
14	C.P. Riser Terminal	2-114-1	Casualty Power Outlet		
15	15 lb CO <sub>2</sub>	2-119-1	Portable fire extinguisher		
16	One OBA		In box at Fr. 110 stbd.		

Figure 12-2.—Compartment checkoff list.

**Student Notes:**

A modified YOKE is sometimes used at sea when cruising independently in good weather and calm seas and in port in peacetime. In the modified condition, YOKE fittings above the waterline are left open to improve ventilation and habitability. All other XRAY and YOKE fittings shipwide will be closed unless logged on a case-by-case basis as discussed earlier.

An alternative to the setting of ZEBRA shipwide is the setting of modified ZEBRA. An example of the setting of modified ZEBRA would be setting Zebra on the DC deck and below only if the area the ship was transiting was a known or suspected hazardous navigational area. This would provide a higher survivability stance than condition YOKE. At the same time modified ZEBRA is less restrictive in the rest of the ship and will more readily allow the accomplishment of other operational requirements. Modified ZEBRA may result as an upgrade from condition YOKE or as a downgrade from condition ZEBRA.

## SPECIAL CLASSIFICATIONS

**Circle XRAY and YOKE.** These fittings are access fittings to battle stations and compartments containing equipment that require periodic checks or fittings that must be opened for ammunition transfer, as well as some systems.

Circle XRAY and YOKE fittings are normally closed when condition XRAY or YOKE are set. They may be opened without special authority when going to or securing from general quarters, transferring ammunition, during periodic space or equipment checks, or during operation of damage control equipment. Circle XRAY and YOKE fittings are marked with a black X or Y in a black circle. They should be secured once passage is complete.

**Circle ZEBRA.** These fittings are closed when condition ZEBRA is set. They may be opened with the permission of the CO only. This would be during extended periods of general quarters for the preparation and distribution of battle messing, to provide access to sanitary facilities, to ventilate battle stations, to transit from squadron ready rooms to the flight deck, and to

allow limited access throughout the ship as the CO prescribes.

Open Circle ZEBRA fittings must be guarded so they can be closed immediately because the ship is still in a battle station position when ZEBRA is set. Circle ZEBRA fittings are marked with a red Z surrounded by a red circle.

**DOG ZEBRA.** These fittings are secured when condition ZEBRA is set and whenever the ship is set for “darken ship,” which is a night steaming condition, not a material condition. During darken ship these fittings and closures are closed to prevent light inside showing to the outside. DOG ZEBRA fittings are marked with a red Z surrounded by a black letter D.

## NOTE

Darken ship is a night steaming condition, not a material condition.

**WILLIAM.** These fittings are vital sea suction, ventilation fittings valves serving vital equipment, and valves that must be open to maintain mobility and fire protection. WILLIAM fittings are open during all material conditions. They are secured only to control damage, contamination, or to repair equipment served. WILLIAM fittings are marked with a black colored letter W.

**Circle WILLIAM.** These fittings, like WILLIAM fittings, are normally open but are secured for protection in CBR attack. Fittings that are marked with this classification are those that provide ventilation opening to the outside of the ship. Circle WILLIAM fittings are marked with a black W surrounded by a black circle.

## REVIEW 4 QUESTIONS

- Q1. What is the most important feature of a ship to ensure its survivability?

---

*Student Notes:*

- Q2. List the three basic material conditions of readiness.
- a.
  - b.
  - c.
- Q3. What material condition provides the least amount of watertightness?
- Q4. When is YOKE normally set?
- Q5. What material condition is set when GQ is sounded?
- Q6. What fittings are closed to set darken ship?
- Q7. To find a list of all DC fittings within a compartment, you should refer to—

### LIFE SUPPORT EQUIPMENT

**Learning Objective:** When you finish this chapter, you will be able to—

- Identify life support equipment used aboard ship.

All life support devices discussed in this chapter are designed to allow the wearers to breath (and thereby to escape), continue work, and assist in saving the ship and their fellow crew members. Remember that the crew must save the ship or no one will be saved. Therefore, the purpose of this section of the chapter is to provide

you with information on the emergency escape breathing device (EEBD), supplemental emergency egress device (SEED), oxygen breathing apparatus (OBA), and self-contained breathing apparatus (SCBA).

### EMERGENCY ESCAPE BREATHING DEVICE (EEBD)

Studies of fire casualties have proven that most casualties are the result of smoke and toxic fumes and not from the fire itself. For this reason, the EEBD (fig. 12-3) was developed for emergency escape. It provides the wearer with 15 minutes of breathable air. It is to be worn until you can get topside during evacuation from below deck spaces. The EEBD is designed to provide respiratory and eye protection in an atmosphere that will not support life. With the proper training you should be able to activate and don an EEBD in less than 30 seconds.

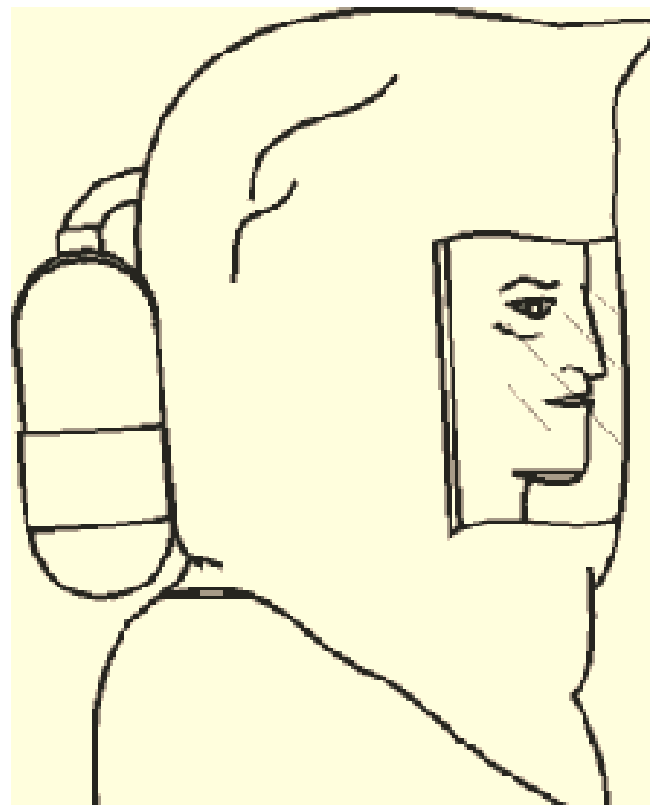

Figure 12-3. —emergency escape breathing device (EEBD)

### *Student Notes:*

## WARNING

EEBDs must not be used for firefighting purposes.

## WARNING

Remember, when donning the EEBD, if you don't hear the hissing sound of oxygen being generated, discard the unit and get another.

## DANGER

Don't smoke immediately after using the EEBD because your hair is saturated with oxygen and could catch on fire.

## SUPPLEMENTAL EMERGENCY EGRESS DEVICE (SEED)

Personnel working in engineering spaces wear supplemental emergency egress devices (SEEDs) on their belts for easy access. When a main space fire is called away, the watch stander should use the SEED (fig. 12-4) to proceed to an EEBD. The watch stander should obtain an EEBD and don it when not in danger of immediate harm from heat or flames. Because the SEED lacks protection for the eyes and nose and has a short operational time, it is a supplemental device. However, it is immediately available for the engineering watch standers and is easily operated on the run. Factors to consider when using these devices include the following:

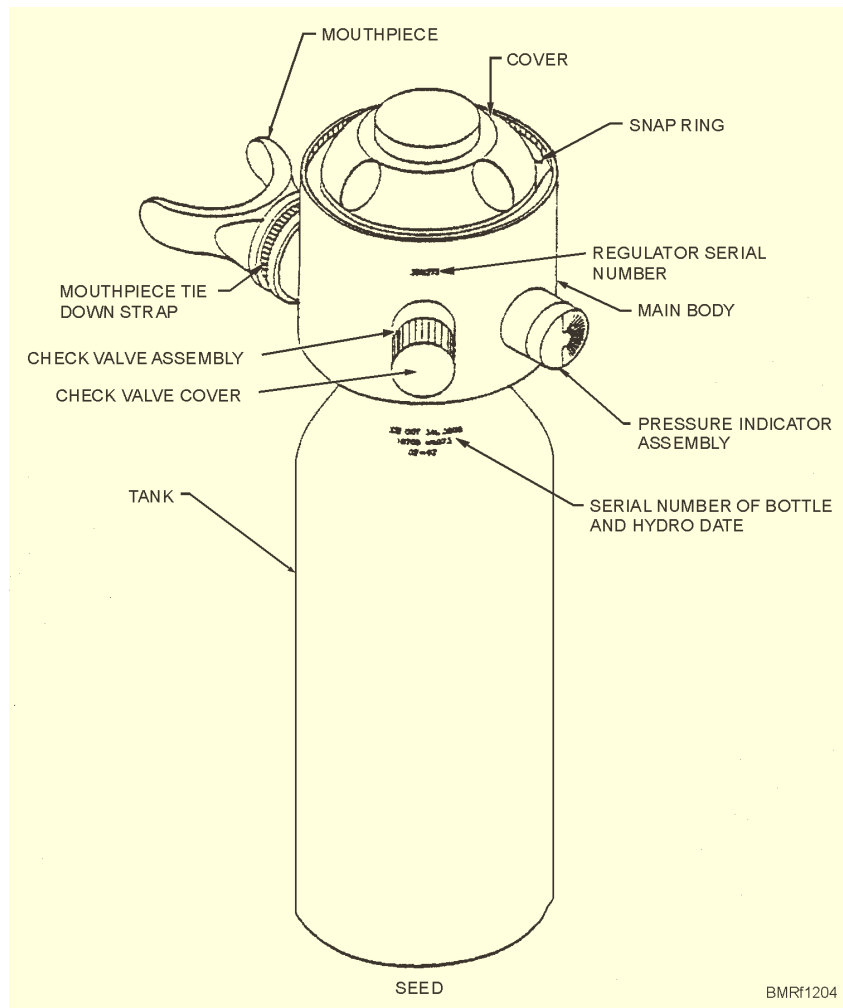

Figure 12-4.—Supplemental emergency egress device (SEED).

### *Student Notes:*

- How quickly conditions are deteriorating
- Ease of egress, including travel time to a breathable atmosphere
- Operating times for each device
- Capabilities and limitations of each device

### WARNING

Don't breath through the nose—breath only through the mouth when using the SEED.

### WARNING

SEEDs must not be used for firefighting purposes.

### OXYGEN BREATHING APPARATUS (OBA)

The oxygen breathing apparatus (OBA) (fig. 12-5) is a self-contained device that generates oxygen through a chemical process and lets the wearer breathe independently of the surrounding atmosphere. Currently, the OBA is the primary tool used by firefighting teams for respiratory protection. The effective time limit of the oxygen supply is in excess of

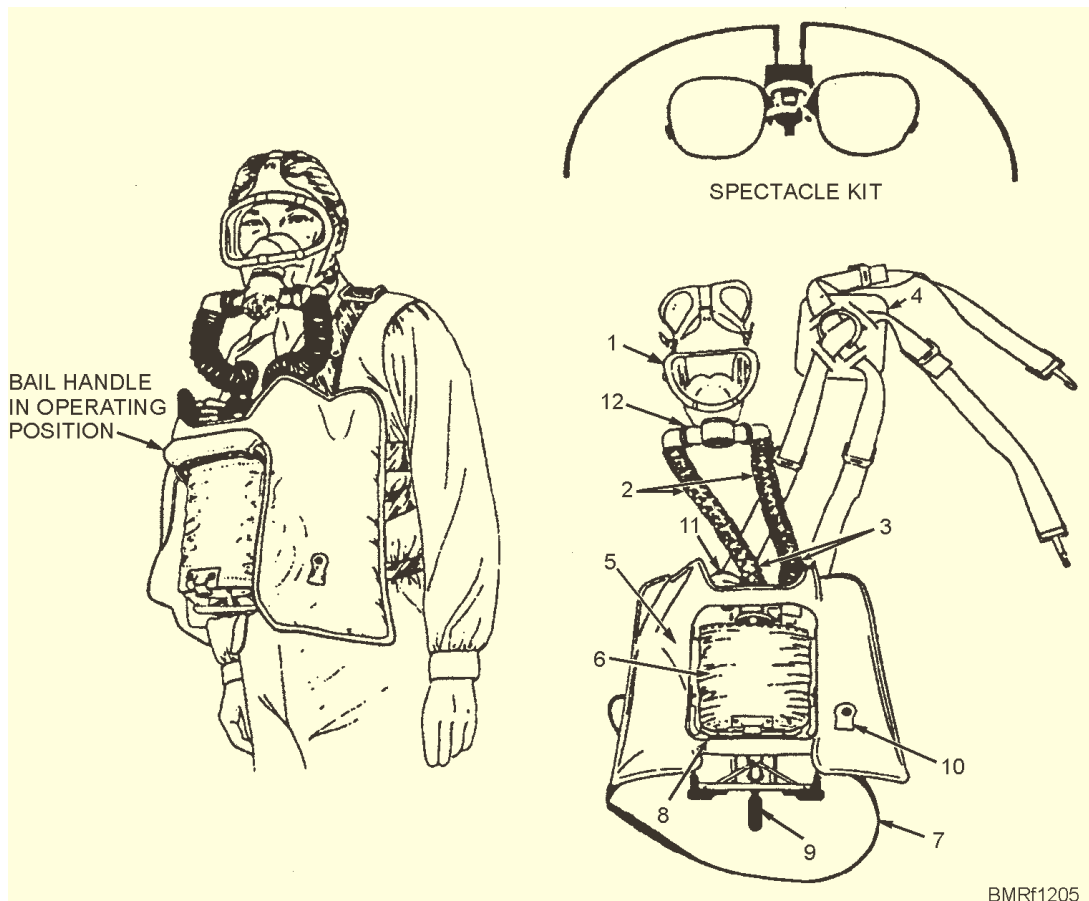

- |                             |  |  |
|-----------------------------|--|--|
| 1. Facepiece                | 5. Breathing bag                           | 9. Canister release strap                    |
| 2. Breathing tubes          | 6. Breastplate                             | 10. Pressure relief valve and pull tab timer |
| 3. Breathing tube couplings | 7. Waist strap                             | 11. Timer                                    |
| 4. Body harness and pad     | 8. Bail assembly handle (standby position) | 12. Valve housing                            |

Figure 12-5.—Navy oxygen breathing apparatus (OBA).

### Student Notes:



45 minutes. For your personnel protection you should set the timer on the OBA for 30 minutes, allowing 15 minutes to leave the area and return to fresh air.

When in operation, the air within the apparatus is continuously replenished with oxygen while the chemicals in the canister remove exhaled carbon dioxide (CO<sub>2</sub>) and water vapor. As a result of this chemical action, the OBA wearer may survive and work in a toxic atmosphere, such as a smoke-filled compartment. With the facepiece and canister in place, using the OBA forms a closed self-sustaining system. For personnel having eyeglasses, a spectacle kit is available for the installation of prescription lenses in the facepiece.

### WARNING

When removing the candle cover, do not remove the cotter pin while pulling the lanyard. Removal of the cotter pin fires the candle and starts generating oxygen. If that happens while the copper foil is intact, internal pressure in the canister will build up, causing the copper foil or canister seam to rupture. Do not pull the cotter pin until the canister is inserted in the OBA and the bail assembly is up and locked.

### CAUTION

Do not pull the breathing bag tab during normal use because the oxygen in the bags will leak into the atmosphere, causing loss of your breathing oxygen.

### WARNING

Never allow grease, oil, or water to enter the neck of the canister. Any of these liquids may cause a violent chemical reaction or explosion. The chemicals contained in the canister are injurious to skin and equipment.

### SELF-CONTAINED BREATHING APPARATUS (SCBA)

The self-contained breathing apparatus (SCBA) (fig. 12-6) is replacing the OBA throughout the Navy. The unit's main components consist of a harness, high-pressure bottle, pressure regulator, full-face mask, and the high- and low-pressure hoses as shown below. High-pressure air cylinders are filled with compressed grade D breathing air and then stored until needed. The cylinders themselves are rechargeable, replacing the need for additional canisters in the OBA system.

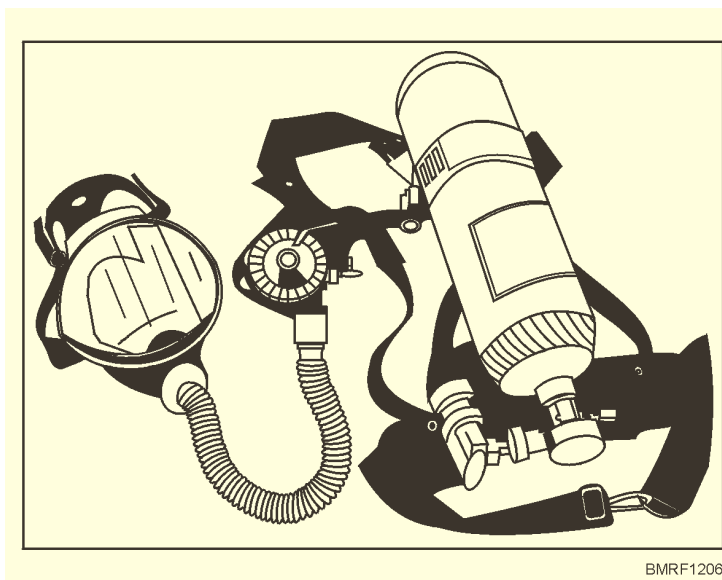

BMRF1206

Figure 12-6.—Self-contained breathing apparatus (SCBA).

---

### *Student Notes:*

Once the cylinder valve has been turned on, it provides a continuous air supply to the system regulator via the high-pressure hose. The pressure is reduced by the regulator for use by the wearer, and the low-pressure hose carries the breathable air into the facepiece. As a safety feature, these are positive pressure style regulators, which means that the air supply to the mask is just above any demand requirements eliminating any possibility of toxic fumes from entering the wearer's mask.

The time each cylinder lasts will be determined by a number of factors. The main factors will be the physical condition and size of the wearer and the work to be done. Generally, each bottle will last approximately 30 minutes from the time it is activated.

### REVIEW 5 QUESTIONS

- Q1. How many minutes of air is the EEBD designed to provide?
- Q2. Why should you stay away from open flames when you first remove an EEBD?
- Q3. What should you listen for when donning an EEBD?
- Q4. What device is worn by engineering watch standers?
- Q5. What is the effective time of an OBA?

- Q6. When do you pull the cotter pin on an OBA canister?

## FIREFIGHTING

**Learning Objectives:** When you finish this chapter, you will be able to—

- Recognize the properties of a fire triangle and fire tetrahedron.
- Identify the conditions necessary for spontaneous combustion.
- Identify the types of heat transfer.

Fire is a constant threat aboard ship. All possible measures must be taken to prevent a fire, or if one is started, to extinguish it quickly. Fires may start from several causes—spontaneous combustion, carelessness, hits by enemy shells, or collision. If the fire is not controlled quickly, it may cause more damage than the initial casualty and could cause the loss of the ship.

### FIRE AND FIREFIGHTING

You cannot win against a fire. You can fight the fire and you can hold down its damage; but some property will be destroyed and, all too often, people will be injured or killed. Time is always lost, productive work is stopped, and additional effort and materials are required to make repairs and to clean up the mess.

The objective of fire prevention, therefore, is to prevent fires from starting. Fire prevention is an all-hands, all-day, all-night, heads-up effort. A cigarette tossed in the wrong direction can cause as much damage as an enemy bomb. An oily wiping rag or a sparking tool can be as dangerous as an open flame in a gasoline depot.

Each ship is required to institute and maintain a fire prevention program. Your part in the fire prevention program is as follows:

- Ensure that all gear is stowed properly.

---

### *Student Notes:*

- Practice good housekeeping procedures, such as the daily removal of trash from spaces.
- Practice safety precautions when working with flammable materials.
- Report all potential fire hazards.
- Keep firefighting equipment handy and in good working order.
- Ensure closures and fittings are working properly and report any discrepancies.

## FIRE TRIANGLE

The entire chemistry and physics of fire and burning, or combustion, can be simplified into a relationship between three components—fuel, heat (temperature), and oxygen (air). To have a fire in any combustible substance, each one of these components must be present to help each other. Picture these components in the form of a triangle, as shown in figure 12-7.

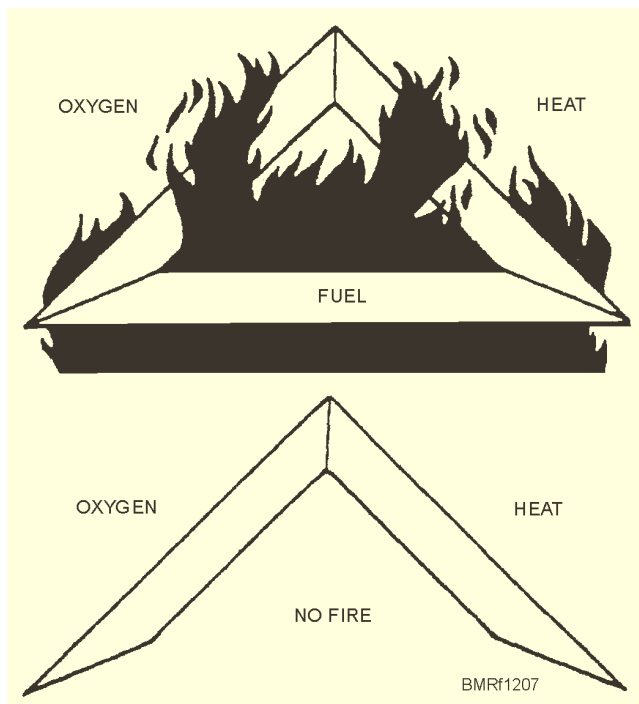

Figure 12-7.—Requirements for combustion.

Look at figure 12-7. Here, you can see that if the oxygen reacts with the fuel, it creates heat, which causes a draft or some other condition that takes in more oxygen and creates still more heat, and so on. Or the heat may cause more fuel to become available (such as causing gasoline to boil into vapor), which then takes more oxygen to burn and creates more heat, which then produces still more fuel, and so on. The burning reaction can go in many different directions.

The modern science of firefighting and fire extinguishment is based on the sides of the fire triangle and an uninhibited chain reaction of burning. Obviously, the firefighter can remove one or more of the components to cause the burning to stop. The type of firefighting agent the firefighter has at hand determines which component or components of the triangle will be removed.

Another way the firefighter can stop the fire (and the combustion) is to place a screen between any two components of the triangle. If the fighter uses an agent as a temporary screen that breaks the triangle, the fire goes out. Obviously, the fire can quickly start up again if this method is used because each of the three necessary components is still there waiting to start the fire again once the screen is gone.

## FIRE TETRAHEDRON

The fire triangle describes the requirements for surface glowing or smoldering, but it doesn't completely describe flaming combustion requirements. A fourth requirement, an uninhibited chain reaction, is needed for flames to exist. This is shown by the fire tetrahedron (fig. 12-8). A tetrahedron is a solid figure with four triangular faces. It is useful for illustrating the flaming combustion process because it provides for the chemical chain reaction requirement and each face touches the other three sides. As described for the fire triangle, flaming combustion stops when one of the four sides of the fire tetrahedron is removed.

## SPONTANEOUS COMBUSTION

Fire, also called *burning* or *combustion*, is a rapid chemical reaction that results in the release of energy in the form of light and heat. Most spontaneous combustion involves very rapid oxidation; that is, the

## Student Notes:

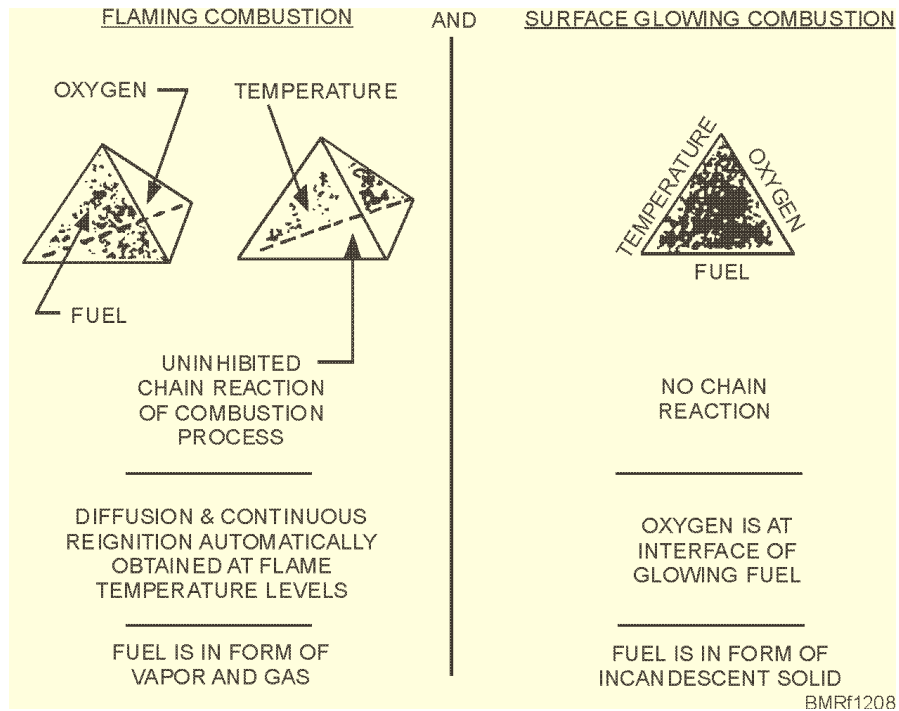

Figure 12-8.—Tetrahedron and fire triangle.

chemical reaction by which oxygen combines chemically with the burning material.

Such things as rags or paper soaked with oil or with paints or solvents are particularly subject to spontaneous combustion if they are stowed in confined spaces where the heat caused by oxidation cannot be dissipated rapidly enough.

A fire involving combustible fuel or other material must have an ignition source, and the material must be hot enough to burn. The lowest temperature at which a flammable material gives off vapors that will burn when a flame or spark is applied is called the *flash point*. The *fire point*, which is usually a few degrees higher than the flash point, is the temperature at which the fuel will continue to burn after it has been ignited. The *ignition* or *self-ignition point* is the lowest temperature to which a material must be heated to give off vapors that will burn without the aid of a spark or flame. In other words, the ignition point is the temperature at which spontaneous combustion occurs. The ignition point is usually at a much higher temperature than the fire point.

### ***Student Notes:***

## **METHODS OF HEAT TRANSFER**

Heat from a fire is transferred by one or more of the following methods:

1. Conduction
2. Convection
3. Radiation

### **Conduction**

Conduction is the transfer of heat through a body or from one body to another by direct physical contact. For example, on a hot stove, heat is conducted through the pot to its contents. Wood is ordinarily a poor conductor of heat, but metals are good conductors. Since most ships are constructed of metal, heat transfer by conduction is a potential hazard. Fire can move from one fire zone to another, one deck to another, and one compartment to another by heat conduction.

Often, the skillful application of water, using fog patterns to rapidly coat and recoat surfaces with a film of water, will slow or halt the transmission of heat by conduction. Fog patterns coat surfaces more efficiently

than solid streams, reducing run off and the effect on ship stability.

### Convection

Convection is the transfer of heat through the motion of circulating gases or liquids. Heat is transferred by convection through the motion of smoke, hot air, and heated gases produced by a fire.

When heat is confined (as within a ship), convected heat moves in predictable patterns. The fire produces lighter than air gases that rise toward high parts of the ship. Heated air, which is lighter than cooler air, also rises. As these heated combustion products rise, cool air takes their place; the cool air is heated, in turn, and then rises to the highest point it can reach.

Hot smoke originating at a fire on a low deck will travel horizontally along passageways, and then upward by way of ladder and hatch openings, heating flammable materials in its path. To prevent fire spread, release the heat, smoke, and gases to the atmosphere. However, the structural design of a ship makes it difficult to rapidly cut openings through decks, bulkheads, or the ship's hull for ventilation. It is imperative that the fire be confined to the smallest possible area. Doors and hatchways should be kept closed when they are not in use. If a fire is discovered, attempts should be made to close off all openings to the fire area until firefighting personnel and equipment can be brought into position to fight the fire.

### Radiation

Heat radiation is the transfer of heat from a source across an intervening space; no material substance is involved. The heat travels outward from the fire in the same manner as light; that is, in straight lines. When it contacts a body, it's absorbed, reflected, or transmitted. Absorbed heat increases the temperature of the absorbing body. For example, radiant heat that is absorbed by an overhead will increase the temperature of that overhead, perhaps enough to ignite its paint.

Heat radiates in all directions unless it's blocked. Radiant heat extends fire by heating combustible substances in its path, causing them to produce vapors, then igniting the vapor.

Within a ship, radiant heat raises the temperature of combustible materials near the fire and, depending on the ship's design, at quite some distance from the fire. Ship fires can spread as a result of radiating bulkheads and decks. Intense radiated heat can make an approach to the fire extremely difficult. For this reason, protective clothing should be worn by firefighters.

### REVIEW 6 QUESTIONS

- Q1. Fire prevention is the responsibility of—
- Q2. List the three components that make up a fire.
  - a.
  - b.
  - c.
- Q3. What process is involved in most cases of spontaneous combustion?
- Q4. List the three methods of heat transfer.
  - a.
  - b.
  - c.

### CLASSES OF FIRE

**Learning Objective:** When you finish this chapter, you will be able to—

- Recognize the four classifications of fire and identify the means used to extinguish them.

Fires are divided into four classifications, each indicating the type of material burning. By knowing the

---

### *Student Notes:*

CLASSES OF FIRE	TYPES OF MATERIALS INVOLVED	METHOD(S) OF EXTINGUISHING
A	Wood and wood products, cloth, textiles and fibrous materials, and paper and paper products.	Water in straight or fog pattern. If the fire is deep-seated, aqueous film forming foam (AFFF) is more effective than seawater and can be used as a wetting agent.
B	Flammable liquids, such as gasoline, diesel fuel (F-76), jet fuels, hydraulic fluid, and lube oil. Also, involves flammable gases.	Extinguished with AFFF, Halon 1211, Halon 1301, or potassium bicarbonate (PKP). Never extinguish flammable gases unless there is a good chance that the flow of gas can be secured. <b>Securing the flow of gas is the single most important step in controlling a gas fire.</b>
C	Energized electrical fires.	Use nonconductive agents, such as CO <sub>2</sub> , Halon 1211, or water spray. Most effective tactic is to de-energize and handle the fire as a class A fire. If fire isn't deep-seated, clean agents that don't a cleanup problem are preferred (CO <sub>2</sub> or Halon 1211).
D	Combustible metals, such as magnesium and titanium.	Water in quantity, using fog patterns. When water is applied to burning class D materials, explosions may occur. Apply water from a safe distance or from behind shelter.

Figure 12-9.—Classes of fire.

class of fire, the primary agent and best method for extinguishing the fire can be determined as shown in figure 12-9.

Many substances, such as liquids, gases, and solids, are used as firefighting agents. The selection and use of these agents varies with the class of fire, its location, and the extent of the fire involvement. Although seawater is the most valuable firefighting agent available based on its endless supply, considerations should always be taken to determine if water is the best agent to put out the type of fire being fought.

## REVIEW 7 QUESTIONS

Q1. Match the class of fire with the types of materials involved.

MATERIALS	CLASSES OF FIRE
a. Hydraulic fluid	A
b. Energized circuit board	B
c. Paper	C
d. Gasoline	D
e. Magnesium	
f. Cloth	
g. Titanium	

---

*Student Notes:*

- Q2. What is the most available heat-removing agent for shipboard use?
- Q3. AFFF was developed to combat what class of fire?
- Q4. CO<sub>2</sub> is the primary agent to disrupt the fire triangle of what class fire?
- Q5. What is an effective agent against a class D fire?

## DAMAGE CONTROL EQUIPMENT

**Learning Objective:** When you finish this chapter, you will be able to—

- Identify the portable equipment and fixed systems that make up the shipboard inventory of protection equipment.

As you've learned in this chapter, damage control is an all hands job. The time it takes to get a fire or flooding under control is vital. You should become familiar with the portable equipment and fixed systems that make up your ship inventory of protection equipment. Because of the large amount of explosives, fuels, and other flammable materials aboard ship, you must know where equipment is located and how to use it before an emergency exists.

Knowing where equipment is and how to use it applies not only to firefighting equipment but also the equipment used for flooding or CBR protection. The equipment and its storage location varies from ship to ship, so you must know your ship.

You may find yourself the first person on the scene, so knowing the basic rules of damage control and equipment usage may make the difference in the loss of many spaces or a shipmate's life. Perhaps you will be called to serve on a fire party or flooding detail. As a

team member, keep in mind, the lack of equipment and procedures could result in a disastrous outcome.

Figures 12-10 through 12-15 show some examples of the equipment that's common to all ships. These figures show only a small amount of what you'll find in a ship's repair locker.

## THE FIREFIGHTER ENSEMBLE

The firefighter's ensemble (fig. 12-10) is used to protect the firefighter from short duration flame (flash) exposure, heat, and falling debris.

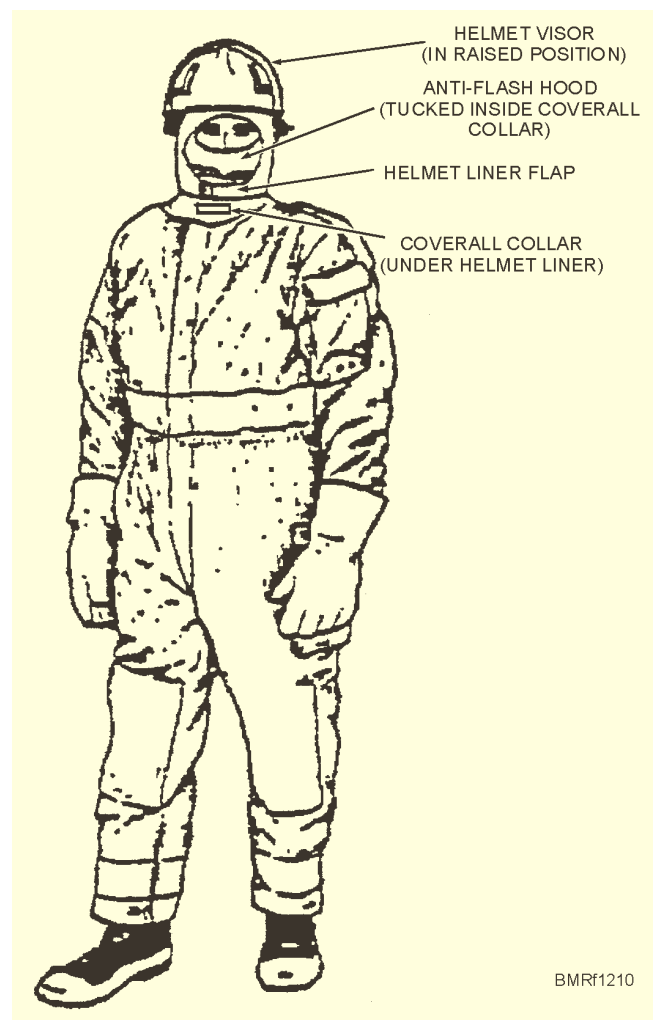

Figure 12-10.—Firefighter's ensemble.

## Student Notes:

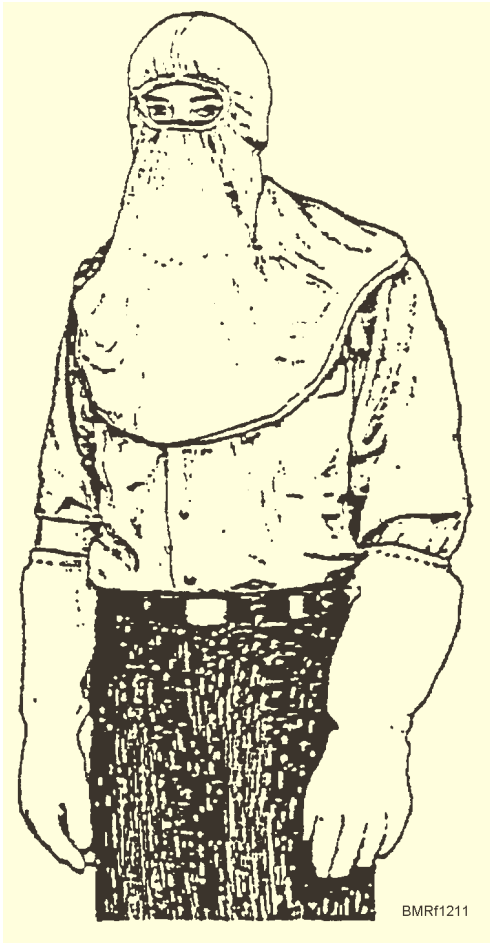

Figure 12-11.—Anti-flash clothing.

## ANTI-FLASH CLOTHING

Anti-flash clothing (fig. 12-11) is used to protect personnel from high temperatures resulting from the use of explosive weapons and from burns caused by fire. The clothing consists of the following two items:

1. Anti-flash hood
2. Anti-flash gloves

## FIRE HOSE STATION

A fire hose station (fig. 12-12) is commonly referred to as either a *fire station* or a *fireplug*. The fire hose station is the location of a fireplug and associated equipment. Branches of the firemain system supply water to the fire hose stations throughout the ship. Generally, fire hose stations aboard frigates and larger

ships have 1 1/2-inch fireplugs and fire hose stations aboard ships larger than frigates have 2 1/2-inch fireplugs.

## P-100 PUMP

The P-100 pump is a diesel-engine-driven portable pump unit. It's designed for firefighting (fig. 12-13) and limited dewatering (fig. 12-14) functions aboard ships.

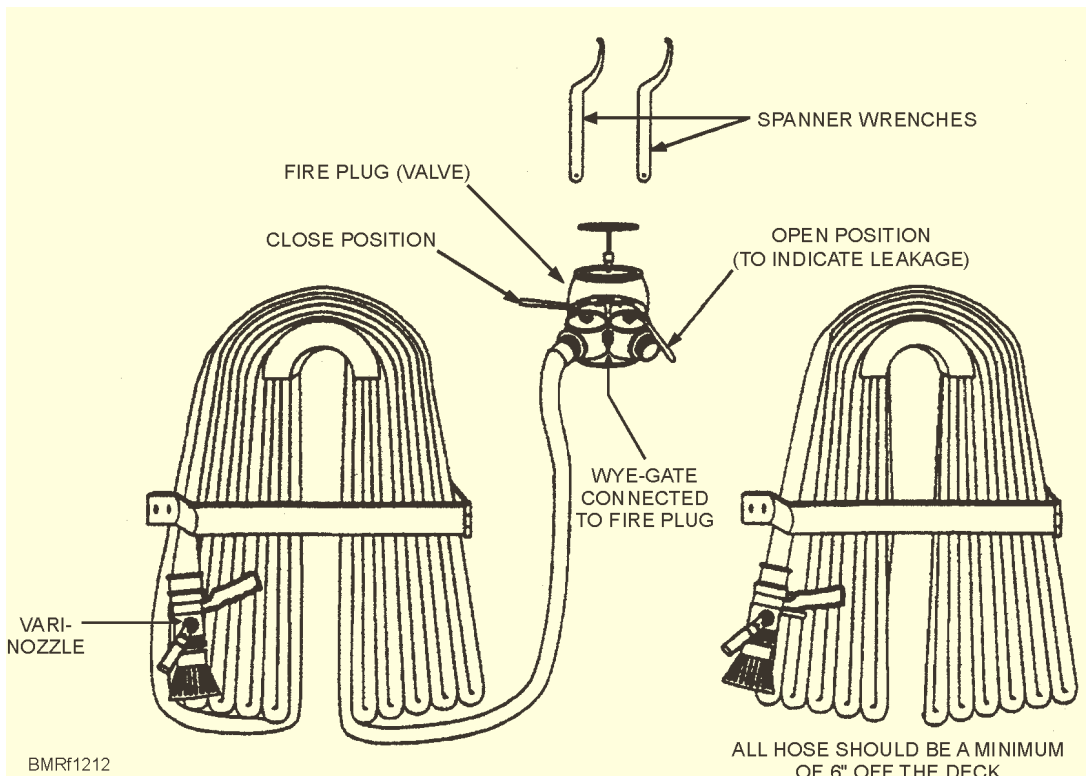

Figure 12-12.—Fire hose station.



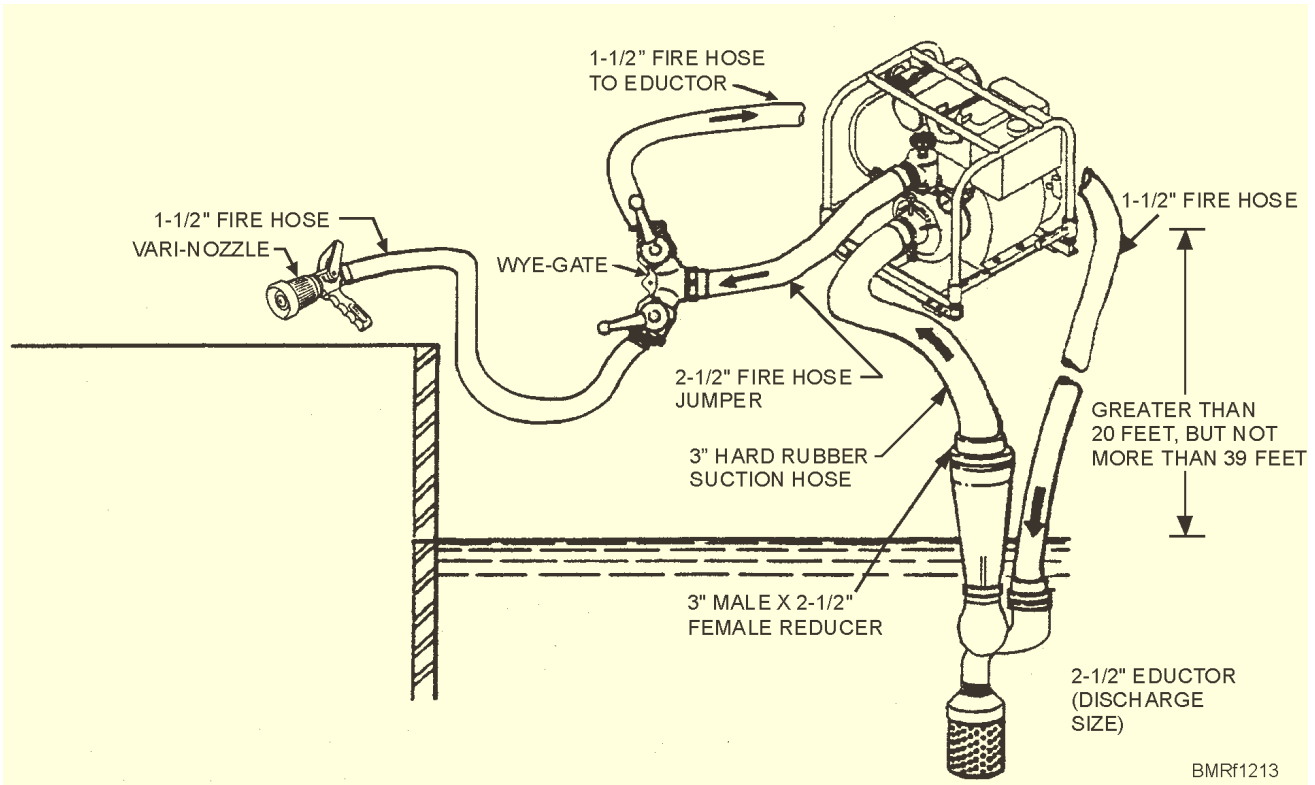

Figure 12-13.—Firefighting hookup.

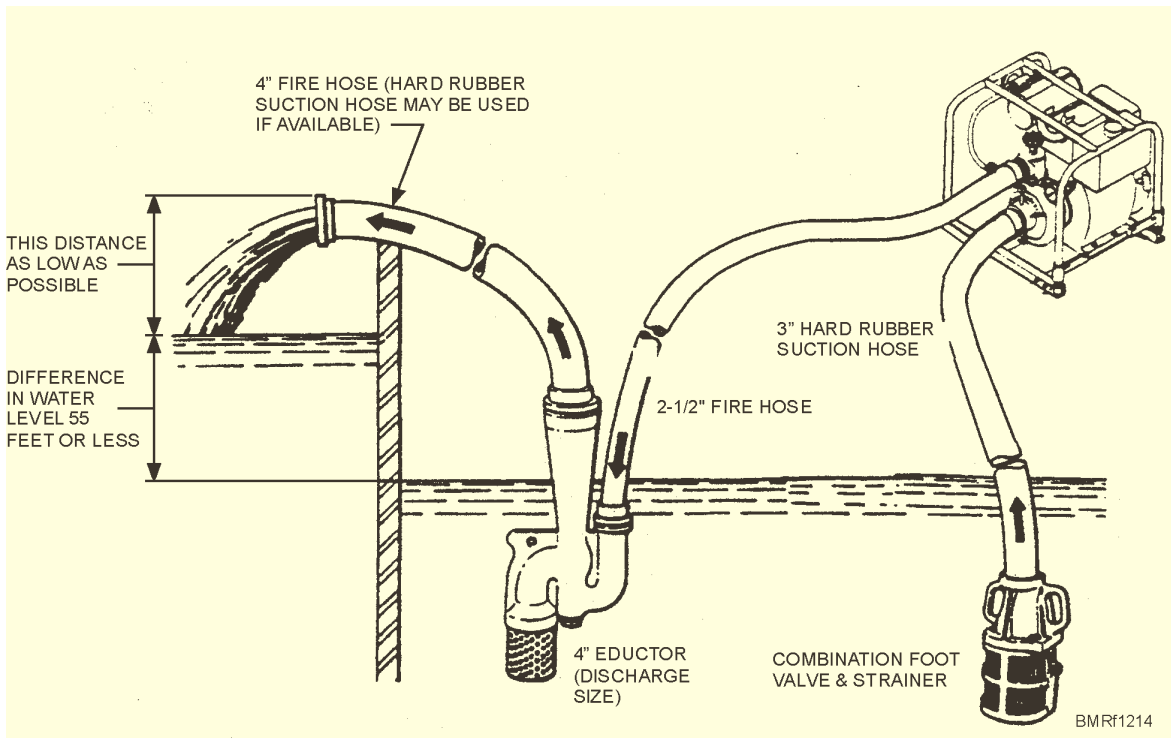

Figure 12-14.—Dewatering hookup.

## DAMAGE CONTROL SHORING CHEST

Each repair station has a damage control shoring chest (fig. 12-15). The chest is divided into three compartments to separate the different tools and materials needed for shoring.

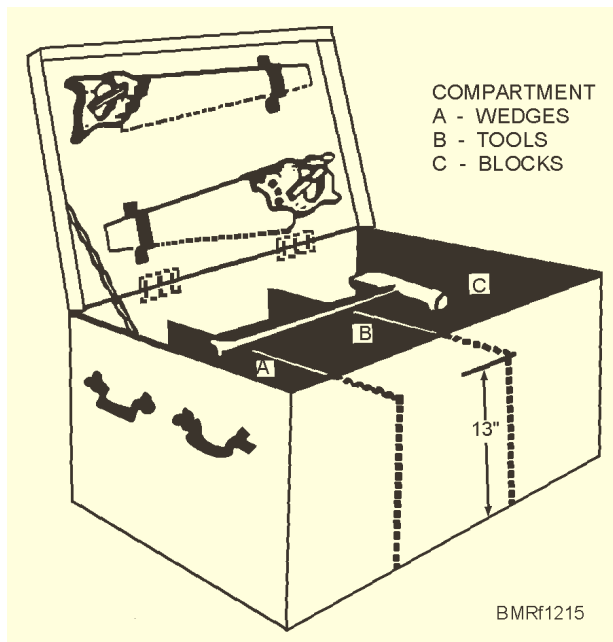

Figure 12-15.—Damage control shoring chest.

### REVIEW 8 QUESTION

Q1. Describe the purpose of the following items.

- a. Damage control shoring chest
- b. P-100 pump
- c. Firefighter ensemble
- d. Anti-flash clothing
- e. Fire hose station

## SUMMARY

A ship lives or dies depending on its crew's ability to combat a wide range of casualties, and these casualties are not restricted to times of conflict. Casualties can occur while moored in your homeport, at anchorage overseas, or during a routine peacetime deployment. The requirement for every person on board, from the commanding officer to the fireroom messenger, to have a good, basic knowledge of damage control procedures and constant training and drills in combating shipboard casualties is essential to the ship's survival. This training and preparation demonstrated during the Persian Gulf crisis saved several U.S. Navy ships that sustained considerable damage. If these crews had not been trained in damage control, these ships and most likely a large portion of their crews may have been lost.

The proper use of the closure log is just as important as knowing how to don an OBA or use a fire hose. The business of damage control is serious. Learn it well; your life, the lives of your shipmates, and your ship depend on it.

### REVIEW 1 ANSWERS

- A1. The damage control organization is divided into the—
  - a. **Administrative organization**
  - b. **Battle organization**
- A2. The purpose of the administrative phase of DC is **to establish and maintain material readiness conditions.**
- A3. **The engineer officer** is responsible for maintaining properly trained DCPOs, repair parties, and repair locker personnel.
- A4. The **XO** is the senior person assigned as team leader on DCTT.

---

*Student Notes:*

- A5. The **DCPO** is responsible for making sure that all battle lanterns, dog wrenches, spanners, and other damage control equipment are in place and in a usable condition within their division.
- A6. Before anyone enters a poorly ventilated space or void, the **gas free engineer (GFE)** certifies the space as safe.

### REVIEW 2 ANSWERS

- A1. The battle phase of damage control starts **when the ship receives actual damage**.
- A2. The battle station for the DCA is **DCC/CSS**.
- A3. DCC receives reports and casualty status from **repair parties**.
- A4. The minimum requirement to be a member of the in-port emergency team is to be **repair party qualified**.
- A5. The primary missions of the rescue and assistance team are **to assist persons from the water, other units in distress, and other persons or activities in distress ashore**.
- A6. **General quarters** is the highest state of readiness.

### REVIEW 3 ANSWERS

- A1. The X40J circuitry is commonly referred to as the **salt and pepper line**.
- A2. The alarms that can override the microphone control of the IMC are the
  - a. **Collision**
  - b. **Chemical attack**
  - c. **General**
  - d. **Flight crash**
- A3. When all communications systems fail, **messengers** are used to deliver messages and orders between repair lockers and DCC.

### REVIEW 4 ANSWERS

- A1. Survivability of the ship can be ensured by **compartmentation**.

- A2. The three basic material readiness conditions are—
  - a. **XRAY**
  - b. **YOKE**
  - c. **ZEBRA**
- A3. Material condition **XRAY** provides the least amount of watertightness.
- A4. Normally, **YOKE** is set at sea and in port during wartime.
- A5. Material condition **ZEBRA** is set when GQ is sounded.
- A6. **DOG ZEBRA** fittings are closed to set darken ship.
- A7. To find a list of all DC fittings within a compartment, you should refer to the **compartment checkoff list**.

### REVIEW 5 ANSWERS

- A1. The EEBD is designed to provide **15 minutes** of air.
- A2. You should stay away from open flames when you first remove an EEBD **because your hair is saturated with oxygen and could catch fire**.
- A3. When donning an EEBD, you should hear a **hissing sound**.
- A4. Engineering watch standers wear a **SEED**.
- A5. The effective time of an OBA is **45 minutes**.
- A6. You pull the cotter pin on an OBA **after the canister has been inserted in the OBA and locked in place**.

### REVIEW 6 ANSWERS

- A1. Fire prevention is the responsibility of **all hands**.
- A2. The three components that make up a fire are—
  - a. **Heat**
  - b. **Fuel**
  - c. **Oxygen**.

- A3. Most cases of spontaneous combustion involve the process of **rapid oxidation**.
- A4. The three methods of heat transfer are—
- Conduction**
  - Radiation**
  - Convection**

### REVIEW 7 ANSWERS

A1.

MATERIALS	CLASSES OF FIRE
a. Hydraulic fluid	<b>B</b>
b. Energized circuit board	<b>C</b>
c. Paper	<b>A</b>
d. Gasoline	<b>B</b>
e. Magnesium	<b>D</b>
f. Cloth	<b>A</b>
g. Titanium	<b>D</b>

- A2. **Sea water** is the most available heat-removing agent for shipboard use.
- A3. AFFF was developed to combat **class B fires**.
- A4. **CO<sub>2</sub>** is the primary agent to disrupt the fire triangle of class C fires.
- A5. **Water fog** is an effective agent against a class D fire.

### REVIEW 8 ANSWERS

- A1. The purposes of the following items are as follows:
- Damage control shoring chest. **A chest that is divided into compartments for storing materials used for shoring.**
  - P-100 pump. **The P-100 pump can be used to fight fires or to dewater spaces.**
  - Firefighter ensemble. **The firefighter ensemble protects personnel from short duration flames, heat, and falling debris.**
  - Anti-flash clothing. **Anti-flash clothing protects personnel from heat caused by high explosive weapons and from burns caused by fire. There are two items that make up anti-flash clothing—anti-flash gloves and the anti-flash hood.**
  - Fire hose station. **The fire hose station is where the fireplug and associated equipment is located.**

# ASSIGNMENT 8

**Textbook Assignment:** Chapter 12 “*Damage Control.*”

---

1. The damage control organization is divided into how many parts?
  1. One
  2. Two
  3. Three
  4. Four

QUESTIONS 2 THROUGH 13 REFER TO THE ADMINISTRATIVE ORGANIZATION OF DAMAGE CONTROL.

2. What person coordinates the efforts of repair parties to control damage?
  1. The damage control assistant
  2. The operations officer
  3. The executive officer
  4. The weapons officer
3. Which of the following are duties of the administrative organization of damage control?
  1. Records and schedules for maintenance
  2. Written doctrine and procedures relating to damage control
  3. Ship’s bills
  4. All of the above
4. Which of the following are duties of the executive officer?
  1. Ship’s survivability training
  2. Readiness to manage casualties
  3. Control and recover from damage
  4. Each of the above
5. What officer is designated as the ship’s damage control officer?
  1. The commanding officer
  2. The executive officer
  3. The engineer officer
  4. The operations officer
6. The DCA is the primary assistant to the damage control officer. As such, the DCA has which of the following responsibilities?
  1. Training the ship’s DC personnel
  2. Administration of the ship’s DC organization
  3. Maintain records of DC personnel PQS accomplishment for all hands
  4. All of the above
7. What requirements must a petty officer have to be designated as the damage control petty officer (DCPO)?
  1. Be a PO2 or above
  2. Complete the PQS
  3. Complete the fire-fighting school
  4. Be designated by the LCPO
8. Normally, the job of DCPO is held for what period of time?
  1. 12 months
  2. 9 months
  3. 3 months
  4. 6 months
9. Which of the following is/are responsibilities of the DCPO?
  1. Assist in the instruction of division personnel in damage control
  2. Prepare and maintain damage control checkoff lists for their spaces
  3. Make required reports
  4. All of the above
10. What person is responsible for determining the safe entry of personnel into closed or poorly ventilated spaces?
  1. The gas free engineer
  2. The fire marshal
  3. The DCA
  4. The XO

11. What person is designated to aid the DCA train personnel and to prevent and fight fires?

1. The gas free engineer
2. The fire marshal
3. The DCPO
4. The LCPO

12. What action is taken if the fire marshal finds hazards that relate to poor housekeeping during a daily inspection?

1. Record and advise the responsible division
2. Submit discrepancy report to DCA with copies to XO and department head
3. Have the division LCPO schedule corrective action
4. Report the hazard to the safety department

13. The fire marshal has which of the following responsibilities?

1. Submitting reports citing hazards and recommendations for their correction
2. Setting up a fire watch team before regular overhauls
3. Both 1 and 2 above
4. Inspecting the engineering department

QUESTIONS 14 THROUGH 17 REFER TO THE BATTLE ORGANIZATION OF DAMAGE CONTROL.

14. What is the purpose of the ship's damage control battle organization?

1. To stand at ready for the battle to be over
2. To restore the ship to as near normal operation as possible
3. To comfort injured crew members
4. When directed, to take charge of the weapons

15. In the damage control battle organization, what person is responsible for controlling damage; fighting fires; CBR countermeasures; and control of stability, list, and trim?

1. The DCPO
2. The DCA
3. The XO
4. The CO

16. What are the primary damage control battle organization unit(s)?

1. Repair parties
2. Navigation crew
3. Deck crews
4. Engineering personnel

17. What is the nerve center of the directing force for directing the damage control organization?

1. DCC or CCS
2. Bridge
3. Aft steering
4. DC locker 5

IN ANSWERING QUESTIONS 18 THROUGH 21, SELECT THE REPAIR PARTY THAT IS IDENTIFIED BY THE FUNCTION USED AS THE QUESTION.

18. Main deck repair.

1. Repair 1
2. Repair 3
3. Repair 5
4. Repair 7

19. Propulsion repair.

1. Repair 1
2. Repair 3
3. Repair 5
4. Repair 7

20. Ordnance.

1. Repair 2
2. Repair 4
3. Repair 6
4. Repair 8

21. Electronic casualty control.

1. Repair 2
2. Repair 4
3. Repair 6
4. Repair 8

22. Each repair party should be capable of performing which of the following functions?

1. Rigging casualty power
2. Controlling flooding
3. Extinguishing all types of fires
4. Each of the above

23. When in port, the ship has which of the following duty section components available to respond to any type of casualty?
  1. In port emergency teams
  2. Salvage teams
  3. Duty DC watch
  4. Deck department
24. The rescue and assistance detail must have which of the following qualifications?
  1. Be qualified as an emergency team member
  2. Be qualified in first aid
  3. Both 1 and 2 above
  4. Have passed the PRT
25. General quarters is an all hands evolution—it is the highest state of readiness of the ship.
  1. True
  2. False
26. Which of the following statements describes a correct GQ route to follow?
  1. Forward in the passageways and down ladders on the starboard side
  2. Aft in the passageways and down ladders on the port side
  3. Forward in the passageways and up ladders on the port side
  4. Aft in the passageways and up ladders on the starboard side
27. Which of the following is an emergency damage control communications system?
  1. 2JZ
  2. 6JZ
  3. X40J
  4. X24J
28. What system signals override microphone control stations to notify the ship's crew of imminent danger?
  1. Alarms for collision, chemical attack, general, and flight crash
  2. General announcing system
  3. DC controls
  4. Bridge alarms

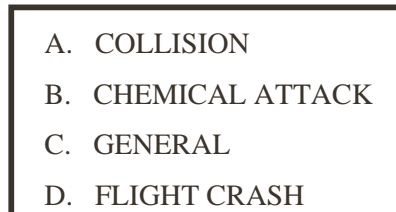

Figure A

IN ANSWERING QUESTIONS 29 THROUGH 31, REFER TO FIGURE A AND SELECT THE TERM USED TO DEFINE THE QUESTION.

29. This alarm is sounded by the OOD or PreFly notifying ship's company of a pending or actual flight deck emergency.
  1. A
  2. B
  3. C
  4. D
30. This alarm is sounded when there is a possibility that the ship will be struck by another waterborne unit.
  1. A
  2. B
  3. C
  4. D
31. When this alarm is sounded, all hands report to their preassigned stations and set material condition ZEBRA.
  1. A
  2. B
  3. C
  4. D
32. Which of the following means of communications is used when all other methods have failed?
  1. Messengers
  2. Sound-powered telephones
  3. Morse Code
  4. Bullhorn
33. All Navy ships have how many material conditions of readiness?
  1. One
  2. Two
  3. Three
  4. Four

34. What material condition provides the least degree of watertight integrity?
1. ZEBRA
  2. YOKE
  3. XRAY
35. What material condition sets the highest degree of watertight integrity?
1. ZEBRA
  2. YOKE
  3. XRAY
36. Which of the following fittings are closed when condition ZEBRA is set?
1. DOG Z fittings
  2. Circle X fittings
  3. Y fittings
  4. All of the above
37. What means, if any, is used by repair parties to find damage control fittings and closures in each compartment?
1. Master alfa list
  2. Compartment checkoff lists
  3. DC compartment checks
  4. None
38. The Damage Control Closure Log is maintained in which of the following locations?
1. DCC
  2. Quarterdeck
  3. Both 1 and 2 above
  4. Engineering spaces
39. Which of the following logs is a list of all DC-related fittings that don't work properly?
1. Damage Control Closure Log
  2. Fire marshal pass down log
  3. Inoperative Fittings and Closures Log
  4. Bridge log
40. What fittings are secured when the ship is set for "darken ship"?
1. WILLIAM
  2. Circle WILLIAM
  3. DOG ZEBRA
  4. Circle ZEBRA
41. The emergency escape breathing device (EEBD) supplies breathable air for what maximum period of time?
1. 10 minutes
  2. 15 minutes
  3. 20 minutes
  4. 25 minutes
42. With training, you should be able to activate the EEBD within what maximum period of time?
1. 10 seconds
  2. 20 seconds
  3. 30 seconds
  4. 40 seconds
43. Which of the following breathing devices should NOT be worn for fire-fighting purposes?
1. OBA
  2. SEED
  3. SCBA
44. Which of the following is the primary fire fighting tool for respiratory protection?
1. EEBD
  2. SEED
  3. OBA
  4. SCBA
45. From the time it is activated, each cylinder used in the self-contained breathing apparatus (SCBA) will last approximately what length of time?
1. 15 minutes
  2. 30 minutes
  3. 45 minutes
  4. 60 minutes
46. Which of the following substances must be present to start a fire?
1. Oxygen
  2. Heat
  3. Fuel
  4. All of the above



47. In the fire tetrahedron, how many components are necessary for combustion?
1. One
  2. Two
  3. Three
  4. Four
48. Flammable materials give off vapors. What is the lowest temperature that these vapors burn when a spark is applied?
1. Ambient temperature
  2. Room temperature
  3. Flash point
  4. Ignition point
49. What term is used to describe the lowest temperature at which spontaneous combustion occurs?
1. Flash point
  2. Ignition point
  3. Ambient temperature
  4. Room temperature
50. Heat from fire can be transferred by how many methods?
1. One
  2. Two
  3. Three
  4. Four
51. What method of heat transfer occurs when heat moves from one body to another by direct contact?
1. Conduction
  2. Convection
  3. Radiation
  4. Reflection
52. What method of heat transfer occurs through the motion of smoke, hot air, and heated gases?
1. Conduction
  2. Convection
  3. Radiation
  4. Reflection
53. What type of heat transfer occurs when heat moves in all direction unless blocked?
1. Conduction
  2. Convection
  3. Radiation
  4. Reflection
54. Which of the following agents should be used to extinguish a class B fire?
1. Water
  2. AFFF
  3. PKP
  4. Both 2 and 3 above
55. Which of the following agents should be used to extinguish class A or D fires?
1. Water
  2. AFFF
  3. PKP
  4. Both 2 and 3 above